

**PROTEUS
RAYZOR 760 /
RAYZOR 760 WMG
user manual**

©2023 ELATION PROFESSIONAL all rights reserved. Information, specifications, diagrams, images, and instructions herein are subject to change without notice. ELATION PROFESSIONAL logo and identifying product names and numbers herein are trademarks of ELATION PROFESSIONAL. Copyright protection claimed includes all forms and matters of copyrightable materials and information now allowed by statutory or judicial law or hereinafter granted. Product names used in this document may be trademarks or registered trademarks of their respective companies and are hereby acknowledged. All non-ELATION brands and product names are trademarks or registered trademarks of their respective companies.

ELATION PROFESSIONAL and all affiliated companies hereby disclaim any and all liabilities for property, equipment, building, and electrical damages, injuries to any persons, and direct or indirect economic loss associated with the use or reliance of any information contained within this document, and/or as a result of the improper, unsafe, insufficient and negligent assembly, installation, rigging, and operation of this product.

Elation Professional USA | 6122 S. Eastern Ave. | Los Angeles, CA. 90040

323-582-3322 | 323-832-9142 fax | www.elationlighting.com | info@elationlighting.com

Elation Professional B.V. | Junostraat 2 | 6468 EW Kerkrade, The Netherlands

+31 45 546 85 66 | +31 45 546 85 96 fax | www.elationlighting.eu | info@elationlighting.eu

Elation Professional Mexico | AV Santa Ana 30 | Parque Industrial Lerma, Lerma, Mexico 52000

+52 (728) 282-7070

DOCUMENT VERSION



Due to additional product features and/or enhancements, an updated version of this document may be available online. Please scan the QR Code with your mobile device or visit www.elationlighting.com for the latest revision/update of this manual, before installation and/or programming.

Date	Document Version	Software Version	DMX Channels	Notes
05/28/2019	1.0	1.2.1	25 / 52 / 80	Initial release
09/30/2019	1.1	N/C	No Change	Included RJ4 data cable note.
10/15/2019	2.0	1.2.2	No Change	Updated System sub menus, DMX Control Channel, RGBW/ SparkLED FX Tables
03/05/2020	2.5	N/C	No Change	Added torque screw setting page
05/12/2020	3.0	N/C	No Change	Added Elation Proteus Rayzor 760 WMG
08/10/2020	3.5	N/C	No Change	Updated thermal
10/14/2020	4.0	N/C	No Change	Updated specifications
02/04/2021	4.5	1.2.4	No Change	Updated primary/secondary modes
03/15/2021	5.0	N/C	No Change	Hibernation/sun protection warning and information
05/20/2021	5.5	N/C	No Change	Updated Maintenance Guidelines
08/15/2022	6.0	N/C	No Change	Updated Introduction, System Menu, DMX Traits, and Torque settings for screws; added RDM; updated formatting
08/23/2022	6.5	1.3	No Change	Updated System Menu
12/20/2022	7.0	N/C	No Change	Added Limited Warranty; updated Specifications, Torque Settings for Screws
03/17/2023	7.5	1.3.3	No Change	Updated System Menu
06/26/2023	7.5	N/C	No Change	Add IP65 page & Center-to-Center dim.

CONTENTS

Introduction	4
IP65	5
Limited Warranty (USA Only)	6
Safety Guidelines	7
Maintenance Guidelines	9
Overview	10
Installation Guidelines	11
Torque Settings for Screws	16
Remote Device Management (RDM)	18
System Menu	19
Record Controller	28
Lighting Console Patching Guidelines	30
DMX Traits	35
Color Temperature Control Table	41
FX Generator Guidelines	42
RGBW FX Table	44
Error Codes	54
Specifications	55
Dimensional Drawings	56
Optional Accessories FCC Statement	57

INTRODUCTION

Please read and understand the instructions in this manual carefully and thoroughly before attempting to operate this device. These instructions contain important safety and use information. **This device is intended for use by trained personnel only, and is not suitable for private use.**

UNPACKING

Every device has been thoroughly tested and has been shipped in perfect operating condition. Carefully check the shipping carton for damage that may have occurred during shipping. If the carton is damaged, carefully inspect the device for damage, and be sure all accessories necessary to install and operate the device have arrived intact. In the event that damage has been found or parts are missing, please contact our customer support team for further instructions. Please do not return this device to your dealer without first contacting customer support. Please do not discard the shipping carton in the trash. Please recycle whenever possible.

IP65 RATED

An IP rated lighting fixture is commonly installed in outdoor environments and has been designed with an enclosure that effectively protects against the ingress (entry) of external foreign objects such as dust and water. The International Protection (IP) rating system is commonly expressed as "IP" followed by two numbers (i.e. IP65) where the numbers define the degree of protection. The first digit (Foreign Bodies Protection) indicates the extent of protection against particles entering the fixture, while the second digit (Water Protection) indicates the extent of protection against water entering the fixture. **An IP65 rated lighting fixture, such as this one, has been designed and tested to protect against the ingress of dust (6) and low-pressure water jets from any direction (5).**

BOX CONTENTS

Omega Brackets (x2)

IP65 Rated 5-pin DMX Cable (x1)

IP65 Rated RJ45 Data Cable (x1) - **FIXTURE TO FIXTURE INTERCONNECTION USE ONLY!**

IP65 Locking Power Cable (x1)

CUSTOMER SUPPORT

Contact ELATION Service for any product related service and support needs.

Also visit forums.elationlighting.com with questions, comments or suggestions.

ELATION SERVICE USA - Monday - Friday 8:00am to 4:30pm PST

323-582-3322 | Fax 323-832-9142 | support@elationlighting.com

ELATION SERVICE EUROPE - Monday - Friday 08:30 to 17:00 CET

+31 45 546 85 63 | Fax +31 45 546 85 96 | support@elationlighting.eu

REPLACEMENT PARTS - please visit parts.elationlighting.com

IP65 RATED

The International Protection (IP) rating system is commonly expressed as “IP” (Ingress Protection) followed by two numbers (i.e. IP65), where the numbers define the degree of protection. The first digit (Foreign Bodies Protection) indicates the extent of protection against particles entering the fixture, and the second digit (Water Protection) indicates the extent of protection against water entering the fixture. An **IP65** rated lighting fixture is designed and tested to protect against the ingress of dust (**6**), and low-pressure water jets from any direction (**5**).

Maritime/Coastal Environment Installations: A coastal environment is seaside adjacent, and caustic to electronics through exposure to atomized salt-water and humidity, whereas maritime is anywhere within 5-miles of a coastal environment.

Maritime installations require additional preparation, and additional service intervals may be needed given the maritime use. In general, IP ratings presuppose freshwater conditions VS maritime conditions, which are typically more “caustic” to IP fixtures (both internally and externally). A duty-cycle may also be needed when units are not in use. During times of high humidity and colder temperatures, condensation may occur internally so the fixture may require a duty-cycle to bring it up to running temperature, allowing any accumulation of moisture to be expelled via the vent valve. Recommendations can change based on installation environmental circumstances.

NOTE: NOT ALL FEATURES LISTED ARE AVAILABLE ON ALL FIXTURES; THE FOLLOWING INSTRUCTIONS MAY NOT APPLY. CONTACT SUPPORT FOR ADDITIONAL DETAILS.

Exterior Maintenance: Inspect the exterior every 30-days. The unit must be powered off/disconnected. The chassis should be inspected for any signs of contaminants. Inspect optics to determine if the lens is obstructed, then clean optics and chassis accordingly. Based on initial finding, schedule maintenance accordingly, keeping in mind that exterior maintenance will be required. Even if the luminaires are NOT in use, maintenance will still be needed given its location (exterior use). The use of a durable type of wax on the chassis is recommended since it will help prevent contaminant build up. Inspect both power and data lines for any signs of contaminants or corrosion. Periodically reapplying di-electric grease, especially in coastal environments. If any signs of corrosion/contaminants are present, clean thoroughly, and/or replace connectors, then reapply di-electric grease. Typically, this should be done annually, or any time an opportunity presents itself. As a preventive measure, annual replacement of both vent valves is recommended. The vent valve membrane can become contaminated and/or clogged causing improper venting of humidity within the luminaire. Inspect all mounting hardware as a precaution.

Interior Maintenance: Inspect the interior every 30-days. The unit must be powered off/disconnected.

- Inspect zoom/focus mechanism, clean optics, lubricate linear bearings (Krytox oil) as needed, inspect belts for wear
- Inspect all rotating effect wheels, manually rotate them, note any resistance
- Inspect all remaining rotating belts for any wear
- Inspect all fans, clean as needed, check rotation, check connections
- Inspect CMY module, manually move flags and check for signs of resistance, and if needed, clean guide rods first, then reapply a thin layer of grease (moly lube)
- Clean interior with low-volume compressed air, then clean optics prior to reassembly of head covers

Although the base has limited moving parts, the pan belt should also be inspected for wear. Remember to always perform an IP test anytime a cover is removed.

There is no specific time frame regarding the routine replacement of parts such as belts/stepper motors, PCBs, or LEDs. These items should only be replaced on an as needed bases, except for cooling fans, which should be replaced once the luminaries reach 10,000-hours. This is a prophylactic measure intended to keep the unit running as cool as possible, insuring proper function of all internal components. A complete service breakdown is available, please contact service@elationlighting.com for any needed parts or manuals.

LIMITED WARRANTY (USA ONLY)

- A. Elation Professional hereby warrants, to the original purchaser, Elation Professional products to be free of manufacturing defects in material and workmanship for a period of two years (730 days), and Elation Professional product rechargeable batteries to be free of manufacturing defects in material and workmanship for a period of six months (180 days), from the original date of purchase. This warranty excludes discharge lamps and all product accessories. This warranty shall be valid only if the product is purchased within the United States of America, including possessions and territories. It is the owner's responsibility to establish the date and place of purchase by acceptable evidence, at the time service is sought.
- B. For warranty service, send the product only to the Elation Professional factory. All shipping charges must be pre-paid. If the requested repairs or service (including parts replacement) are within the terms of this warranty, Elation Professional will pay return shipping charges only to a designated point within the United States. If any product is sent, it must be shipped in its original package and packaging material. No accessories should be shipped with the product. If any accessories are shipped with the product, Elation Professional shall have no liability what so ever for loss and/or damage to any such accessories, nor for the safe return thereof.
- C. This warranty is void if the product serial number and/or labels are altered or removed; if the product is modified in any manner which Elation Professional concludes, after inspection, affects the reliability of the product; if the product has been repaired or serviced by anyone other than the Elation Professional factory unless prior written authorization was issued to purchaser by Elation Professional; if the product is damaged because not properly maintained as set forth in the product instructions, guidelines and/or user manual.
- D. This is not a service contract, and this warranty does not include any maintenance, cleaning or periodic check-up. During the periods as specified above, Elation Professional will replace defective parts at its expense, and will absorb all expenses for warranty service and repair labor by reason of defects in material or workmanship. The sole responsibility of Elation Professional under this warranty shall be limited to the repair of the product, or replacement thereof, including parts, at the sole discretion of Elation Professional. All products covered by this warranty were manufactured after January 1, 1990, and bare identifying marks to that effect.
- E. Elation Professional reserves the right to make changes in design and/or performance improvements upon its products without any obligation to include these changes in any products theretofore manufactured.
- F. No warranty, whether expressed or implied, is given or made with respect to any accessory supplied with the products described above. Except to the extent prohibited by applicable law, all implied warranties made by Elation Professional in connection with this product, including warranties of merchantability or fitness, are limited in duration to the warranty periods set forth above. And no warranties, whether expressed or implied, including warranties of merchantability or fitness, shall apply to this product after said periods have expired. The consumer's and/or dealer's sole remedy shall be such repair or replacement as is expressly provided above; and under no circumstances shall Elation Professional be liable for any loss and/or damage, direct and/or consequential, arising out of the use of, and/or the inability to use, this product.
- G. This warranty is the only written warranty applicable to Elation Professional products and supersedes all prior warranties and written descriptions of warranty terms and conditions heretofore published.

WARRANTY RETURNS

All returned service items whether under warranty or not, must be freight pre-paid and accompany a return authorization (R.A.) number. The R.A. number must be clearly written on the outside of the return package. A brief description of the problem as well as the R.A. number must also be written down on a piece of paper and included in the shipping container. If the unit is under warranty, you must provide a copy of your proof of purchase invoice. Items returned without a R.A. number clearly marked on the outside of the package will be refused and returned at customer's expense. You may obtain a R.A. number by contacting customer support.

SAFETY GUIDELINES

This fixture is a sophisticated piece of electronic equipment. To guarantee a smooth operation, it is important to follow all instructions and guidelines in this manual. Elation Professional is not responsible for injury and/or damages resulting from the misuse of this fixture due to the disregard of the information printed in this manual. Only qualified and/or certified personnel should perform installation of this fixture and only the original rigging parts (omega brackets) included with this fixture should be used for installation. Any modifications to the fixture and/or the included mounting hardware will void the original manufacturer's warranty and increase the risk of damage and/or personal injury.



PROTECTION CLASS 1 - FIXTURE MUST BE PROPERLY GROUNDED.



**THERE ARE NO USER SERVICEABLE PARTS INSIDE THIS UNIT.
DO NOT ATTEMPT ANY REPAIRS YOURSELF; DOING SO WILL VOID YOUR MANUFACTURER'S WARRANTY. DAMAGES RESULTING FROM MODIFICATIONS TO THIS FIXTURE AND/OR THE DISREGARD OF SAFETY INSTRUCTIONS AND GUIDELINES IN THIS MANUAL VOID THE MANUFACTURER'S WARRANTY AND ARE NOT SUBJECT TO ANY WARRANTY CLAIMS AND/OR REPAIRS.**



ENSURE ALL CONNECTIONS AND END CAPS ARE PROPERLY SEALED WITH A DIELECTRIC GREASE (AVAILABLE AT MOST ELECTRICAL SUPPLIERS) TO PREVENT WATER CORROSION AND/OR ELECTRICAL SHORT CIRCUIT.



**DO NOT PLUG FIXTURE INTO A DIMMER PACK!
NEVER OPEN THIS FIXTURE WHILE IN USE!
UNPLUG POWER BEFORE SERVICING FIXTURE!
NEVER TOUCH FIXTURE DURING OPERATION, AS IT MAY BE HOT!
KEEP FLAMMABLE MATERIALS AWAY FROM FIXTURE!**



**NEVER LOOK DIRECTLY INTO THE LIGHT SOURCE!
RETINA INJURY RISK - MAY INDUCE BLINDNESS!
SENSITIVE PERSONS MAY SUFFER AN EPILEPTIC SHOCK!**



**MINIMUM DISTANCE TO OBJECTS/SURFACES
MUST BE 3.3 FEET (1 METERS)
MAXIMUM TEMP OF EXTERNAL SURFACE 185° F (85°C)
MINIMUM DISTANCE OF INFLAMMABLE MATERIALS
FROM THE SURFACE 1.6 FEET (0.5 METER)**

SAFETY PRECAUTIONS

- **DO NOT TOUCH** the fixture housing during operation. Turn OFF the power and allow approximately 15 minutes for the fixture to cool down before servicing.
- **DO NOT** shake fixture, and avoid brute force when installing and/or operating fixture.
- **DO NOT** operate fixture if the power cord is frayed, crimped, damaged and/or if any of the power cord connectors are damaged and do not insert into the fixture securely with ease.
- **NEVER** force a power cord connector into the fixture. If the power cord or any of its connectors are damaged, replace it immediately with a new one of the same power rating.
- **DO NOT** block any air ventilation slots.
- All fan and air inlets must remain clean and never blocked.
- Allow approx. 6" (15cm) between fixture and other devices or a wall for proper cooling.
- Always disconnect fixture from main power source before performing any type of service and/or cleaning procedure.
- Only handle the power cord by the plug end. Never pull out the plug by tugging the wire portion of the cord.
- During the initial operation of this fixture, a light smoke or smell may emit from the interior of the fixture. This is a normal process and is caused by excess paint in the interior of the casing burning off from the heat associated with the lamp and will decrease gradually over time.
- Consistent operational breaks will ensure fixture will function properly for many years.
- **ONLY** use the original packaging and materials to transport the fixture in for service.

MAINTENANCE GUIDELINES



DISCONNECT POWER BEFORE PERFORMING ANY MAINTENANCE!

CLEANING

Frequent cleaning is recommended to ensure proper function, optimized light output, and an extended life. The frequency of cleaning depends on the environment in which the fixture operates: damp, smoky or particularly dirty environments can cause greater accumulation of dirt on the fixture's optics. Periodically clean the external lens surface with a soft cloth to avoid dirt/debris accumulation. **NEVER** use alcohol, solvents, or ammonia-based cleaners.

MAINTENANCE

Regular inspections are recommended to ensure proper function and extended life. There are no user serviceable parts inside this fixture. Please refer all other service issues to an authorized Elation service technician. Should you need any spare parts, please order genuine parts from your local Elation dealer.

Please refer to the following points during routine inspections:

- A detailed electric check by an approved electrical engineer every three months, to make sure the circuit contacts are in good condition and prevent overheating.
- Be sure all screws and fasteners are securely tightened at all times. Loose screws may fall out during normal operation, resulting in damage or injury as larger parts could fall.
- Check for any deformations on the housing, color lenses, rigging hardware, and rigging points (ceiling, suspension, trussing). Deformations in the housing could allow for dust to enter into the fixture. Damaged rigging points or unsecured rigging could cause the fixture to fall and seriously injure a person(s).
- Electric power supply cables must not show any damage, material fatigue or sediments. **NEVER** remove the ground prong from the power cable.

FIXTURE DISASSEMBLY

The following points should be observed after performing any maintenance procedure that requires disassembly of the unit:

- After the unit has been reassembled, open the valve and allow the unit to run for approximately 2 hours in order to dry out any moisture that has been trapped inside the fixture. The process should continue until indicated humidity drops below 15% for the head and 30% for the base.
- Once this has been achieved, the light can be switched off, but the unit should remain connected to power so that the cooling fan can cool down the unit. Please note that allowing cool down time should **ALWAYS** be done after lamp operation.
- Some units may require partial disassembly in order to gain access to the valve. Please contact Elation service for information regarding the location and access procedure for the valve on your specific unit model.

OVERVIEW

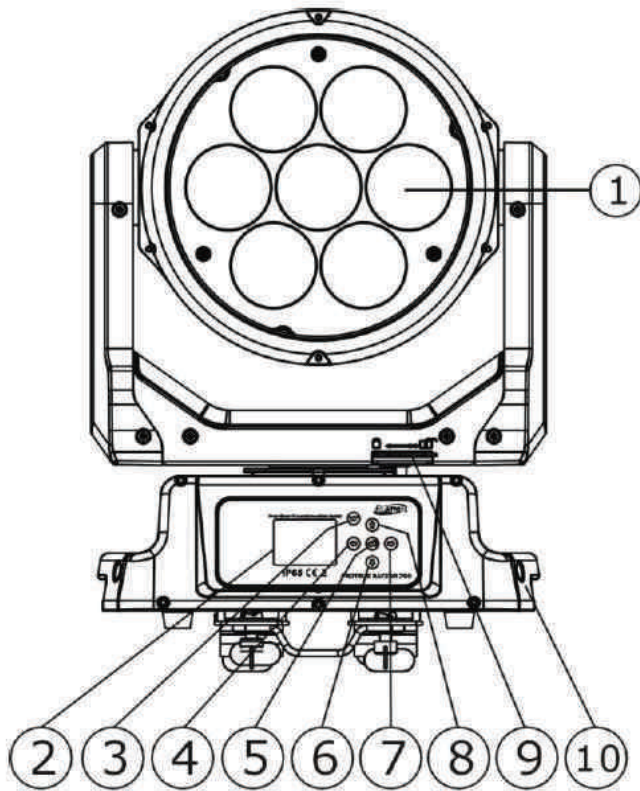

1. Lens
2. System Menu LCD Display
3. Mode/Esc Button
4. Left Button
5. Enter Button
6. Down Button
7. Right Button
8. Up Button
9. Pan Lock
10. Carrying Handle(s)
11. 5-pin DMX Output
12. 5-pin DMX Input
13. RJ45 Output
14. RJ45 Input
15. Fuse
16. Service Port
17. Value
18. Power Input

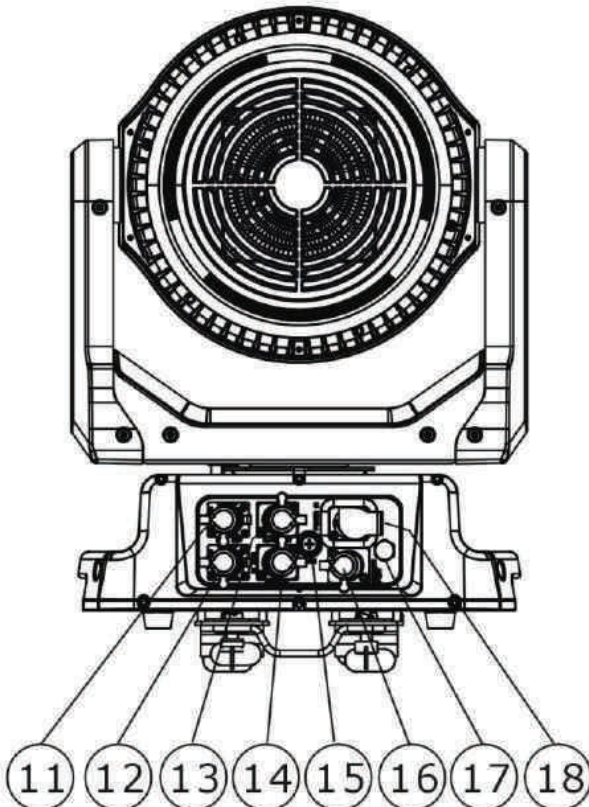

INSTALLATION GUIDELINES



FLAMMABLE MATERIAL WARNING

Keep fixture minimum 5.0 feet (1.5m) away from flammable materials and/or pyrotechnics.



ELECTRICAL CONNECTIONS

A qualified electrician should be used for all electrical connections and/or installations.



MINIMUM DISTANCE TO SURFACES/OBJECTS IS 3.3 FEET (1 METER).

MINIMUM DISTANCE TO FLAMMABLE MATERIALS IS 1.6 FEET (0.5 METER).

EXTERNAL SURFACE CAN REACH TEMPERATURES OF 185° F (85° C).



DO NOT INSTALL THE FIXTURE IF YOU ARE NOT QUALIFIED TO DO SO!

Fixture **MUST** be installed following all local, national, and country commercial electrical and construction codes and regulations.

Before rigging/mounting a single fixture or multiple fixtures to any metal truss/structure or placing the fixture(s) on any surface, a professional equipment installer **MUST** be consulted to determine if the metal truss/structure or surface is properly certified to safely hold the combined weight of the fixture(s), clamps, cables, and accessories.

Overhead rigging requires extensive experience, including calculating working load limits, installation material being used, and periodic safety inspection of all installation material and the fixture, among other skills. If you lack these qualifications, do not attempt the installation yourself. Improper installation can result in bodily injury.

Fixture ambient operating temperature range is **-4° to 113°F (-20° to 45°C)**. Do not operate the fixture when the ambient temperature falls outside of this range.

Fixture(s) should be installed away from walking paths, seating areas, or areas where unauthorized personnel might reach the fixture by hand.

NEVER stand directly below the fixture(s) when rigging, removing, or servicing.

Overhead fixture installation must always be secured with a secondary safety attachment, such as an appropriately rated safety cable.

Allow approximately 15 minutes for the fixture to cool down before serving.

INSTALLATION GUIDELINES

OMEGA BRACKET INSTALLATION

Insert the Omega Brackets into the matching holes on the bottom of the fixture. Secure the Omega Brackets to the fixture by turning each quick-lock fastener ¼ turn clockwise. **Always check to make sure that each fastener is completely locked.** Omega brackets can be installed into the underside of the fixture's base as illustrated below.



CLAMP INSTALLATION

When mounting the fixture to a truss, be sure to secure appropriately rated professional grade rigging clamps to the included Omega Brackets using an M10 screw fitted through the center hole of the Omega Brackets. **This fixture requires the installation of two Omega brackets and two clamps for secure truss mounting.** The fixture also provides built-in rigging points for a SAFETY CABLE. Be sure to only use the designated rigging point for the safety cable and never secure a safety cable to a carrying handle.



**SAFETY CABLE:
ALWAYS ATTACH A SAFETY CABLE WHENEVER INSTALLING
THIS FIXTURE IN A SUSPENDED ENVIRONMENT TO ENSURE
THAT THE FIXTURE WILL NOT FALL IF THE CLAMP FAILS.**

ART-NET | sACN CONNECTION

When connecting fixture to a network switch to control multiple devices, a Gigabit Ethernet Switch that supports IGMP (Internet Group Management Protocol) is required. Using a Gigabit Ethernet Switch that does not support IGMP can cause erratic behavior of all connected devices to the switch. Click link below for more information about IGMP.

https://en.wikipedia.org/wiki/Internet_Group_Management_Protocol

INSTALLATION GUIDELINES

POWER AND DATA CABLES



TO MAINTAIN THE IP65 RATING INTEGRITY OF THE FIXTURE, ALL CABLES MUST BE RUN TOWARDS THE GROUND IN ORDER TO PREVENT WATER ACCUMULATION AROUND THE CONNECTIONS.

SYSTEM MENU
LCD DISPLAY

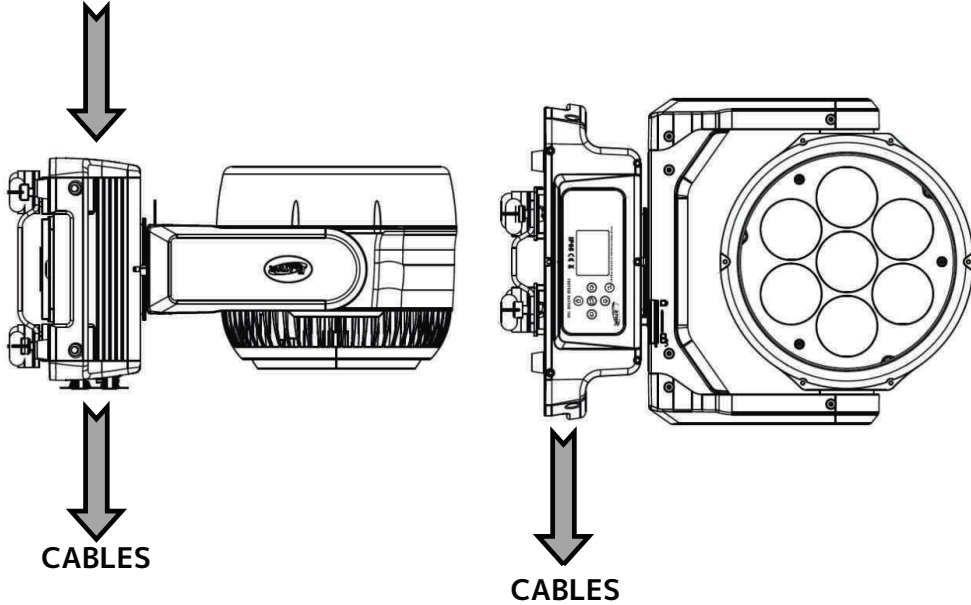

RJ45 DATA CABLES



THE INCLUDED RJ45 DATA CABLE IS FOR FIXTURE TO FIXTURE INTERCONNECTIONS ONLY! THE RJ45 CABLE CONNECTORS MAY NOT BE COMPATIBLE WITH OTHER RJ45 OR ETHERNET TYPE CONNECTORS.

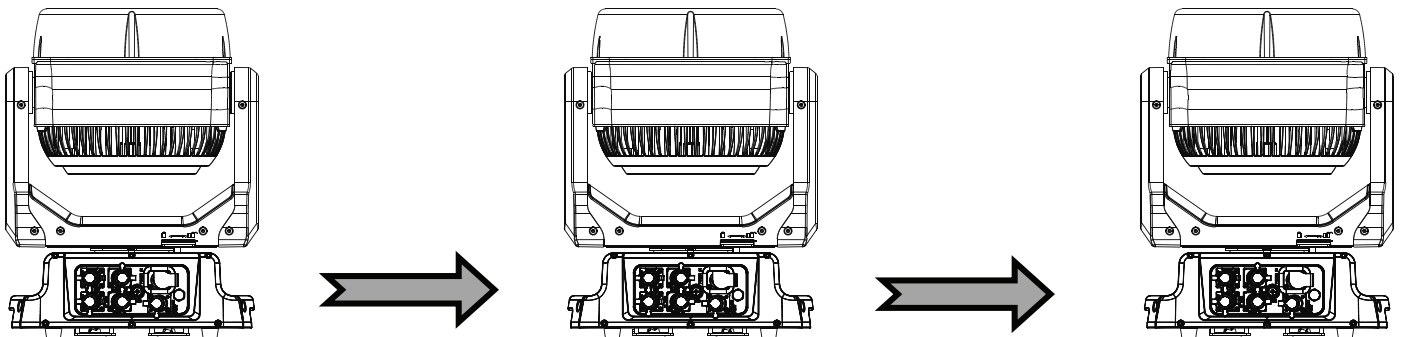

INSTALLATION GUIDELINES

POWER AND DATA CONNECTIONS



ENSURE ALL CONNECTIONS AND END CAPS ARE PROPERLY SEALED WITH A DIELECTRIC GREASE (AVAILABLE AT MOST ELECTRICAL SUPPLIERS) IN ORDER TO PREVENT WATER CORROSION AND/OR ELECTRICAL SHORT CIRCUIT.



TO MAINTAIN IP65 RATING INTEGRITY AND PREVENT WATER FROM ENTERING THE FIXTURE, SEAL ALL UNUSED CONNECTION RUBBER CAPS.

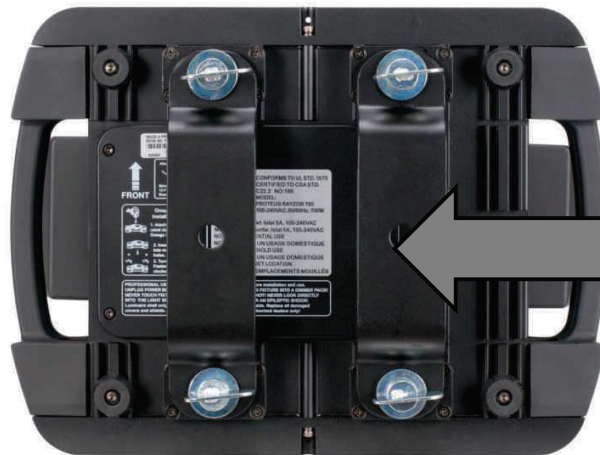

**SAFETY
CABLE
LOOP**



ALWAYS ATTACH A SAFETY CABLE WHENEVER INSTALLING THIS DEVICE IN A SUSPENDED ENVIRONMENT TO ENSURE THE FIXTURE WILL NOT FALL IF THE CLAMP FAILS!

INSTALLATION GUIDELINES

POTENTIAL INTERNAL FIXTURE DAMAGE FROM EXTERNAL SOURCES OF LIGHT BEAMS

External sources of light beams from direct sunlight, lighting and moving head fixtures, and lasers, which are focused directly towards the exterior housing and/or penetrate the front lens opening of Elation lighting fixtures, can cause severe internal damage including burning of optics, dichroic color filters, glass and metal gobos, prisms, animation wheels, frost filters, iris, shutters, motors, belts, wiring, discharge lamps, and LEDs.

This issue is not specific only to Elation lighting fixtures, but rather it is a common issue with lighting fixtures from all manufacturers. Although there is no true way to fully prevent this issue from happening, the guidelines below can reduce the risk of potential damage. Contact Elation Service for more details.

DO NOT EXPOSE THE FIXTURE AND/OR FRONT LENS OPENING TO LIGHT BEAMS FROM DIRECT SUNLIGHT, OTHER LIGHTING OR MOVING HEAD FIXTURES, AND LASERS DURING UNPACKING, INSTALLATION, USE, AND EXTENDED IDLE TIMES OUTDOORS. DO NOT FOCUS A LIGHT BEAM FROM ONE LIGHTING FIXTURE DIRECTLY TOWARDS ANOTHER.

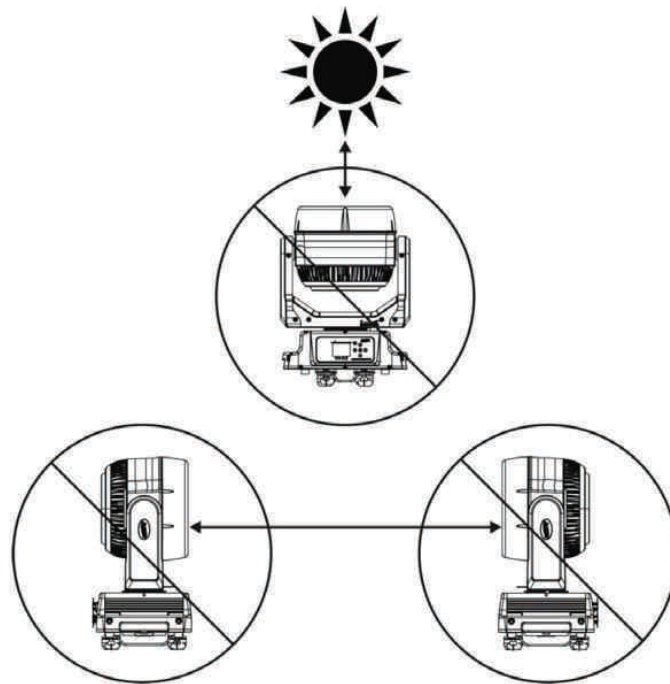

SUN PROTECTION MODE / HIBERNATION MODE

This state can be set via DMX, or the fixture will go into this state after 3 minutes without a DMX signal.

When the sun protection is activated, the pan-and-tilt function of the moving-head will position the lens away from direct sunlight, or other high intensity light source, to protect the internal belts, electronics etc. from burn damage.

When the unit is in the 'sun protection state', it uses its accelerometer sensors (X-Y-Z) (only present on discharge units and IP units) to position the front lens downwards, even when the unit(s) is moved from its position. This will keep on changing the position of the head.

Please note that 'manual mode' overrides the 'sun-protection mode'. The hibernation function is an existing feature that puts the unit into a 'sleep state' to save power (this is a state where only the electronics remain on, and all other functions are turned off). This state is automatically activated when no DMX signal is present for a pre-defined period time (1-99min or off).

TORQUE SETTINGS FOR SCREWS



PANEL SCREWS MUST BE TIGHTENED WITH A TORQUE WRENCH ACCORDING TO THE TORQUE SPECIFICATION DESCRIBED BELOW.



The hex-head screws holding the panels **MUST** be tightened with a torque wrench (Torque Wrench Not Included).

TORQUE SETTING = 11 lbf-in. (12.7kgf-cm)



CAUTION! DO NOT OVER TORQUE SCREWS AS THIS CAN CAUSE LEAKAGE ISSUES! TO CONFIRM THE IP65 INTEGRITY AFTER A PROCEDURE REQUIRING DISASSEMBLY/REASSEMBLY, TEST THE FIXTURE USING THE IP TESTER. CONTACT ELATION SERVICE FOR MORE DETAILS.



CAUTION! THE USE OF PROTECTIVE GLOVES AND SAFETY GOGGLES IS STRONGLY RECOMMENDED WHILE PERFORMING THE IP PRESSURE TEST! AVOID PLACING YOUR FACE, EYES, HANDS, ETC IN CLOSE PROXIMITY TO THE FIXTURE'S LENS WHILE PERFORMING THE TEST!

TORQUE SETTINGS FOR SCREWS



CAUTION! DO NOT OVER TORQUE SCREWS AS THIS CAN CAUSE LEAKAGE ISSUES! TO CONFIRM THE IP65 INTEGRITY AFTER A PROCEDURE REQUIRING DISASSEMBLY/REASSEMBLY, TEST THE FIXTURE USING THE IP TESTER. CONTACT ELATION SERVICE FOR MORE DETAILS.



CAUTION! THE USE OF PROTECTIVE GLOVES AND SAFETY GOGGLES IS STRONGLY RECOMMENDED WHILE PERFORMING THE IP PRESSURE TEST! AVOID PLACING YOUR FACE, EYES, HANDS, ETC IN CLOSE PROXIMITY TO THE FIXTURE'S LENS WHILE PERFORMING THE TEST!



IP PRESSURE TESTING PARAMETERS			
Test Type	Minimum Pressure	Maximum Pressure	Steady/Hold Time
Vacuum Test	-1.88 psi (-13.00 KPa)	-2.46 psi (-17.00 KPa)	10 sec
Pressure Test	1.88 psi (13.00 KPa)	2.46 psi (17.00 KPa)	10 sec

REMOTE DEVICE MANAGEMENT (RDM)

NOTE: In order for RDM to work properly, RDM enabled equipment must be used throughout the entire system, including DMX data splitters and wireless systems.

Remote Device Management (RDM) is a protocol that sits on top of the DMX512 data standard for lighting, allowing the DMX systems of the fixtures to be modified and monitored remotely. This protocol is ideal for instances in which a unit is installed in a location that is not easily accessible.

With RDM, the DMX512 system becomes bi-directional, allowing a compatible RDM enabled controller to send out a signal to devices on the wire, as well as allowing the fixture to respond (known as a GET command). The controller can then use its SET command to modify settings that would typically have to be changed or viewed directly via the unit's display screen, including the DMX Address, DMX Channel Mode, and Temperature Sensors.

FIXTURE RDM INFORMATION:

RDM Code	Device ID	Device Model ID	Personality ID
0x608	1544	Open	Open

Please be aware that not all RDM devices support all RDM features, and therefore it is important to check beforehand to ensure that the equipment that you are considering includes all of the features that you require.

The following parameters are accessible in RDM on this device:

Sensor Definition
Sensor Value
Device Model Description
Manufacturer Label
Device Label
DMX Personality
DMX Personality Description
Device Hours
Lamp Hours
Lamp State
Pan Invert
Tilt Invert
Display Invert

SYSTEM MENU

The fixture includes an easy to navigate system menu. The control panel (see image below) is located on the front of the fixture and provides access to the main system menu where all necessary system adjustments can be made. During normal operation, pressing MODE/ESC button once will access the fixture's main menu. Once in the main menu, you can navigate through the different functions and access the sub-menus with the UP, DOWN, RIGHT, and LEFT buttons. Once you reach a field that requires adjusting, press the ENTER button to activate that field and use the UP and DOWN buttons to adjust the field. Pressing the ENTER button once more will confirm your setting. You may exit the main menu at any time without making any adjustments by pressing the MODE/ESC button.

To access the LCD Menu Control Display via the internal battery, press and hold the MODE/ESC button for 10 seconds. The LCD Menu Control Display will shut OFF automatically about 1 minute from the last button press.

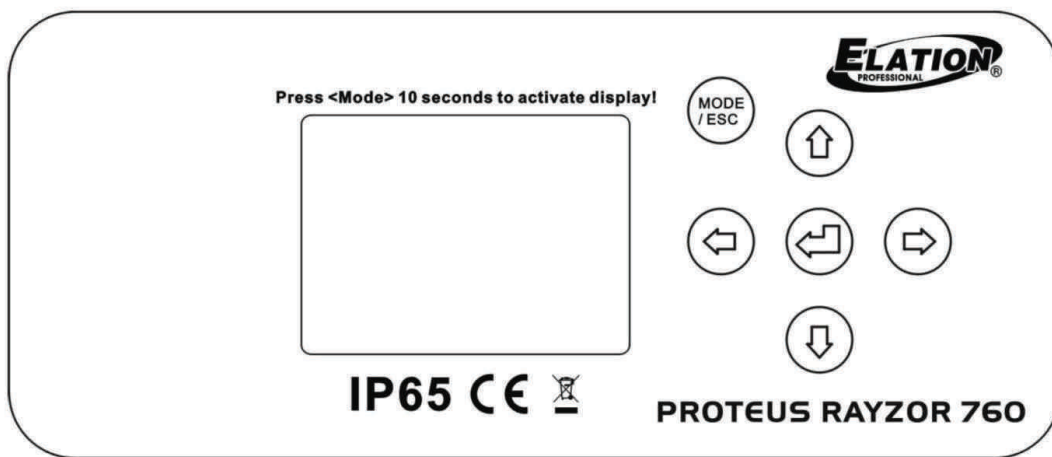

BATTERY

This unit features a dedicated battery that can be used to power the screen display. This allows the user to configure the device's channel mode, DMX address, or any other screen-accessible features without needing to power on the device or even connect it to a power source. To activate the display on battery power, press and hold the MODE button for 3 seconds.

ALTHOUGH E-FLY SETTINGS MAY APPEAR IN THE SYSTEM MENU, THIS FEATURE IS NOT ACTIVATED. E-FLY WIRELESS DMX IS AN OPTIONAL FEATURE WHICH MUST BE ACTIVATED IN THE SERVICE MENU. PLEASE CONTACT ELATION SERVICE FOR FURTHER DETAILS.

SYSTEM MENU (V1.2.1)

Supports Software Versions: 1.2.1

Features subject to change without notice.
Rotation direction (clockwise/counter-clockwise) and control of effects depend on head orientation and pan/tilt settings. Default settings listed in **bold**.

MAIN MENU	SUB MENU	OPTIONS / VALUES		DESCRIPTION	
FUNCTION	Set DMX Address	A001 - Axxx		Set DMX address	
	DMX Value	All...		Display DMX value	
	Secondary Mode	Secondary1		Active secondary mode and select grouping	
		Secondary2			
		Secondary3			
Auto Program	Primary / Alone				
INFORMATION	Time Information	Current Time	xxxx hours	Run hours since fixture was powered on	
		Total Run Time	xxxx hours	Total fixture lifetime run hours	
		Last Run Time	xxxx hours	Run hours since last reset	
		Last Run Password	038		
		Clear Last Run	On / Off	Clear Last Run Time	
	Temperature Info	LED Temperature	xxx C / xxx F		
		Head Temperature	xxx C / xxx F		
		Base Temperature	xxx C / xxx F		
	Humidity Info	Head Humidity	xx %		
		Base Humidity	xx %		
	Ethernet IP	xxx.xxx.xxx.xxx		Displays fixture ethernet address	
	Fan Info	Head Fan 1	xxxx RPM		
			Standby / Fault		
			
		Head Fan 6	xxxx RPM		
			Standby / Fault		
		Base Fan 1	xxxx RPM		
Standby / Fault					
Base Fan 2	xxxx RPM				
	Standby / Fault				
Software Version	Vx.x.x				
Error Info	Error Record 1 - 10		Displays last 10 error codes		

SYSTEM MENU (V1.2.1)

Supports Software Versions: 1.2.1				
MAIN MENU	SUB MENU	OPTIONS / VALUES		DESCRIPTION
PERSONALITY	Status Settings	Address via DMX	On / Off	
		No DMX Status	Close	
			Hold	
			Auto	
		Pan Reverse	On / Off	
		Tilt Reverse	On / Off	
		Pan Degree	360 / 540	
		Tilt Degree	360 / 270	
		Pan Tilt Path	Shortest Path	
			Continue Path	
		Feedback	On / Off	
	LED Degree Change	0 / 180		
	Hibernation	Off, 01min - 99min	Default = 15min	
	Service Setting	Password = 050		
		RDM UID	22A6xxxxxxxx	RDM PID Code
		Clear Err Info	On / Off	Clear error info
		USB Update	Yes / No	Service port for software updates
	Fan Control	Auto		
		High		
		Silent		
	Display Setting	Shutoff Time	02min - 60min	Default = 05min
		Display Reverse	On / Off	Flip display 180 degrees
		Key Lock	On / Off	Key Lock
	Temperature C/F	Celsius / Fahrenheit		
	Initial Status	Control = xxx		Initial effect position
	Select Signal	DMX Only		DMX In / Out
		Art-Net		Select Art-Net
		sACN		Activate sACN
	Ethernet IP	xxx.xxx.xxx.xxx		
	Ether Mask IP	xxx.xxx.xxx.xxx		
	Set Universe	000 - 32767		Set ArtNet universe
	Dimmer Mode	Standard		
		Stage		
		TV		
		Architectural		
		Theatre		
	Refresh	Stage 2		
		900Hz - 1500Hz, 2500Hz, 4000Hz, 5000Hz, 6000Hz, 10000Hz, 15000Hz, 20000Hz, 25000Hz		Select LED refresh rate; Default = 1200Hz
	Dimmer Curve	Linear		
		Square		
Inverse Square				
S-Curve				
Reset Default	On / Off	Passcode = 011	Restore to factory settings	

SYSTEM MENU (V1.2.1)

Supports Software Versions: 1.2.1					
MAIN MENU	SUB MENU	OPTIONS / VALUES		DESCRIPTION	
RESET FUNCTION	Reset All				
	Reset Pan & Tilt				
	Reset Others				
EFFECT ADJUST	Test Channel	Pan...		Test each individual function	
	Manual Control	Pan = xxx, ...		Fine adjustment to each function	
	Calibration	Passcode = 050			
USER MODE SET	User Mode	Standard		Select DMX channel mode	
		Pixels			
		Extended			
EDIT PROGRAM	Select Program	Auto Pro Part 1 = Program 1-10 (Program 1)		Select programs to be run	
		Auto Pro Part 2 = Program 1-10 (Program 2)			
		Auto Pro Part 3 = Program 1-10 (Program 3)			
	Edit Program	Program 1	Program Test		Testing program
			Step01 = SCxxx		Program In Loop
			Step64 = SCxxx		Save and exit
		
		Program 10	Program Test		Testing program
			Step01 = SCxxx		Program In Loop
	Step64 = SCxxx		Save and exit		
	Edit Scenes	Edit Scene 001 ~ Edit Scene 250	Pan, Tilt, ...		Save and automatically return
			--Fade Time-- ~ --Scene Time--		Manual scenes edit
			Input by Outside		Stores scenes via external DMX control
Rec Controller	xx - xx		Automatic scene recorder		

SEE FOLLOWING PAGES FOR SYSTEM MENU REVISIONS.

SYSTEM MENU (V1.2.2)

REVISED SUB MENUS WITH SOFTWARE UPDATE VERSION 1.2.2					
MAIN MENU	SUB MENU	OPTIONS / VALUES		DESCRIPTION	
PERSONALITY	Dimmer Mode	Standard		Set Dimmer Mode	
		Stage			
		TV			
		Architectural			
		Theatre			
		Stage 2			
				0.0 s	Set Delay Time
				0.1 s	
				0.2 s	
				0.3 s	
				0.4 s	
				0.5 s	
				0.6 s	
				0.7 s	
				0.8 s	
				0.9 s	
			Delay Time	1.0 s	
				1.5 s	
				2.0 s	
				2.5 s	
		3.0 s			
		4.0 s			
		5.0 s			
		6.0 s			
		7.0 s			
		8.0 s			
		9.0 s			
		10.0 s			

SYSTEM MENU (V1.3)

REVISED SUB MENUS WITH SOFTWARE UPDATE VERSION 1.3				
MAIN MENU	SUB MENU	OPTIONS / VALUES		DESCRIPTION
PERSONALITY	Status Settings	Address Via DMX	On / Off	Set Dimmer Mode
		No DMX Status	Close	
			Hold	
			Auto	
			SunProt	Sun Protection Mode
		Pan Reverse	On / Off	
		Tilt Reverse	On / Off	
		Pan Tilt Path	Shortest Path	
			Continue Path	
		Feedback	On / Off	
	LED Degree Change	0 / 180		
	Sun Protection	On / Off		
	Hibernation	Off, 01min - 99min	Default = 15min	

	Set Universe	000 - 32767		
	DHCP	On / Off		Automatic IP address assignment
Dimmer Mode	
...	

SYSTEM MENU (V1.3.3)

Supports Software Version 1.3.3

MAIN MENU	SUB MENU	OPTIONS / VALUES		DESCRIPTION	
FUNCTION	Set DMX Address	A001 - Axxx		Set DMX address	
	DMX Value	All...		Display DMX value	
	Secondary Mode	Secondary1		Active secondary mode and select grouping	
		Secondary2			
Secondary3					
Auto Program	Primary / Alone				
INFORMATION	Time Information	Current Time	xxxx hours	Run hours since fixture was powered on	
		Total Run Time	xxxx hours	Total fixture lifetime run hours	
		Last Run Time	xxxx hours	Run hours since last reset	
		Last Run Password	038		
		Clear Last Run	On / Off	Clear Last Run Time	
	Temperature Info	LED Temperature	xxx C / xxx F		
		Head Temperature	xxx C / xxx F		
		Base Temperature	xxx C / xxx F		
	Humidity Info	Head Humidity	xxx %		
		Base Humidity	xxx %		
	Ethernet IP	Ethernet IP xxx.xxx.xxx.xxx xxx.xxx.xxx.xxx		Displays fixture ethernet address	
	Fan Info	Head Fan 1: xxxx RPM ...		Fan speed information	
	Software Version	Vx.x.x			
Error Info	Error Record 1 - 10		Displays last 10 error codes		

SYSTEM MENU (V1.3.3)

Supports Software Version 1.3.3				
MAIN MENU	SUB MENU	OPTIONS / VALUES		DESCRIPTION
PERSONALITY	Status Settings	Address via DMX	On / Off	
		No DMX Status	Close	
			Hold	
			Auto	
			Sun Prot	
		Pan Reverse	On / Off	
		Tilt Reverse	On / Off	
		Pan Degree	360 / 540	
		Tilt Degree	360 / 270	
		Pan Tilt Path	Shortest Path	
			Continue Path	
	Feedback	On / Off		
	LED Degree Change	0 / 180		
	Hibernation	Off, 01min - 99min	Default = 15min	
	Service Setting	Password = 050		
		Clear Err Info	On / Off	Clear error info
		USB Update	Yes / No	Service port for software updates
	Fan Control	Auto		
		High		
		Silent		
	Display Setting	Shutoff Time	02min - 60min	Default = 05min
		Display Reverse	On / Off	Flip display 180 degrees
		Key Lock	On / Off	Key Lock
	Temperature C/F	Celsius / Fahrenheit		
	Initial Status	Pan = xxx ...		Initial effect position
	Select Signal	DMX Only		DMX In / Out
		Art-Net		Select Art-Net
		sACN		Activate sACN
	Ethernet IP	xxx.xxx.xxx.xxx		Set IP address
	Ether Mask IP	xxx.xxx.xxx.xxx		Set subnet mask
	Set Universe	000 - 32767		Set ArtNet universe
	DHCP	On / Off		Auto assign IP address
	Dimmer Mode	Standard		
		Stage		
		TV		
		Architectural		
		Theatre		
		Stage 2		
	Refresh	900Hz - 1500Hz, 2500Hz, 4000Hz, 5000Hz, 6000Hz, 10000Hz, 15000Hz, 20000Hz, 25000Hz		Select LED refresh rate; Default = 1200Hz
		Dimmer Curve	Linear	
Square				
Inverse Square				
S-Curve				
Reset Default	On / Off	Passcode = 011	Restore to factory settings	

SYSTEM MENU (V1.3.3)

Supports Software Version 1.3.3					
MAIN MENU	SUB MENU	OPTIONS / VALUES		DESCRIPTION	
PERSONALITY	Dimmer Curve	Linear			
		Square			
		Inverse Square			
		S-Curve			
	Reset Default	On / Off	Passcode = 011	Restore to factory settings	
RESET FUNCTION	Reset All				
	Reset Pan & Tilt				
	Reset Others				
EFFECT ADJUST	Test Channel	Pan...		Test each individual function	
	Manual Control	Pan = xxx, ...		Fine adjustment to each function	
	Calibration	Passcode = 050 Pan = xxx, ...			
USER MODE SET	User Mode	Standard		Select DMX channel mode	
		Pixels			
		Extended			
EDIT PROGRAM	Select Program	Auto Pro Part 1 = Program 1-10 (Program 1)		Select auto programs to run	
		Auto Pro Part 2 = Program 1-10 (Program 1)			
		Auto Pro Part 3 = Program 1-10 (Program 1)			
	Edit Program	Program 1 - 10	Program Test		Testing program
			Step01 = SCxxx		Program In Loop
			Step64 = SCxxx		Save and exit
	Edit Scenes	Edit Scene 001 ~ Edit Scene 250	Pan, Tilt, ...		Save and automatically return
			--Fade Time-- --Scene Time--		Manual scenes edit
Input by Out			Stores scenes via external DMX control		
Rec Controller	xx - xx			Automatic scene recorder	

RECORD CONTROLLER

WORKING WITH BUILT-IN PROGRAMS

A Primary unit can send up to 3 different data groups to the Secondary units. In other words, a Primary unit can operate up to 3 different Secondary units, with each Secondary unit operating a different set of programs. The Primary unit sends the 3 program parts in a continuous loop.

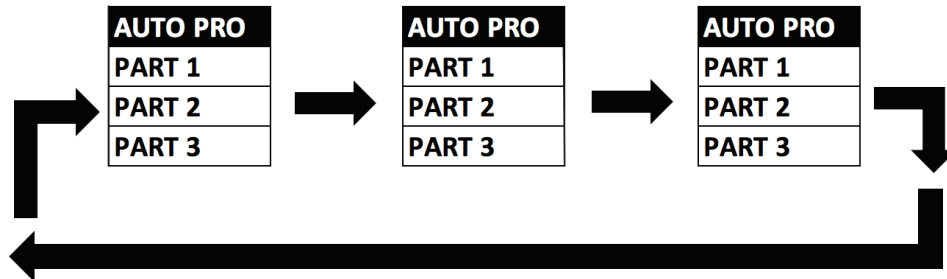

The Secondary unit receives data from the Primary unit according to the group that the Secondary unit was assigned to. For example, suppose we have a unit that has been assigned as a “Secondary 1” unit. Upon receiving the 3-part Auto Program from the Primary unit, the Secondary 1 unit will implement Part 1 of the Auto Program, while ignoring Part 2 and Part 3.

To start running an Auto Program, follow the directions below:

- 1. Set the Secondary unit(s) to the desired Secondary group.** In the main menu of any unit that you want to set as a Secondary, navigate to Function > Secondary Mode. Select “Secondary 1”, “Secondary 2”, or “Secondary 3” to designate the desired Secondary group. Press ENTER to confirm, and press MODE/ESC to return to the main menu,
- 2. Set the Primary unit.** In the Main Menu of the unit you want to set as the Primary, navigate to Function > Auto Program. Select “Primary” and press ENTER to confirm. Then press MODE/ESC to return to the main menu.
- 3. Program selection for each part of the Auto Program.** In the main menu of the Primary unit, navigate to Edit Program > Select Programs. Select “Auto Pro Part 1”, then select which program (1 - 10) to set as Part 1. Press ENTER to confirm. Repeat the process for “Auto Pro Part 2” and “Auto Pro Part 3”.
- 4. Program selection for edit program.** In the main menu of the Primary unit, navigate to Edit Program > Edit Program, then press ENTER. Select the desired program to edit specific scenes into a specific program, then press ENTER to confirm.
- 5. Automatic Scene Recording.** In the main menu of the Primary unit, navigate to Edit Program > Edit Scenes, then press ENTER. Select the desired scene numbers, noting that a maximum of 250 scenes can be programmed. Press ENTER to confirm.

See the following page for an example.

RECORD CONTROLLER

EXAMPLE: WORKING WITH BUILT-IN PROGRAMS

Program 2 includes scenes: 10, 11, 12, & 13

Program 4 includes scenes: 8, 9, & 10

Program 6 includes scenes: 12, 13, 14, & 15

Auto Pro Part 1 is Program 2

Auto Pro Part 2 is Program 3

Auto Pro Part 3 is Program 6

The 3 Secondary groups run the Auto Program in certain time segments, as illustrated in the diagram below.

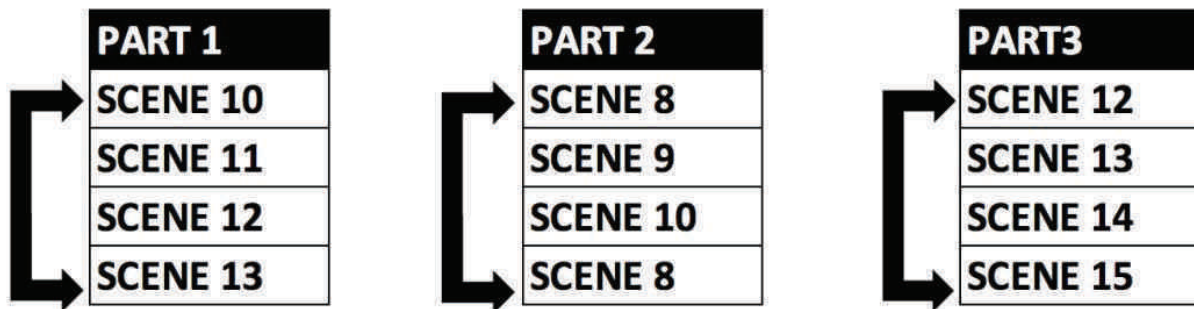

LIGHTING CONSOLE PATCHING GUIDELINES

The PROTEUS RAYZOR 760 is a versatile luminaire which combines two fixtures into one housing, allowing it to produce multiple unique lighting effects typically not found in a single lighting fixture. The DMX layout is designed to offer a variety of options for controlling each fixture efficiently.

The main fixture contains 7x 60W RGBW pixel cells, while the SparkLED fixture contains 28 x 2W white LEDs. For ease of use the DMX layout is arranged to allow lighting consoles to separate the fixture into multiple segments or parts. It is especially important to arrange the fixture in such segments or parts when using the fixture in the full extended 80 channel DMX mode. For simpler programming, reduced DMX channel modes can be used. However, for easy recall of interesting pixel animations, both the RGBW and SparkLED fixtures contain two FX systems: one which controls the RGBW cells, and a second that is dedicated to the Spark LEDs.

The pixels are arranged in a grid pattern as illustrated below. (RGBW 1-7 | SparkLED 1-28)

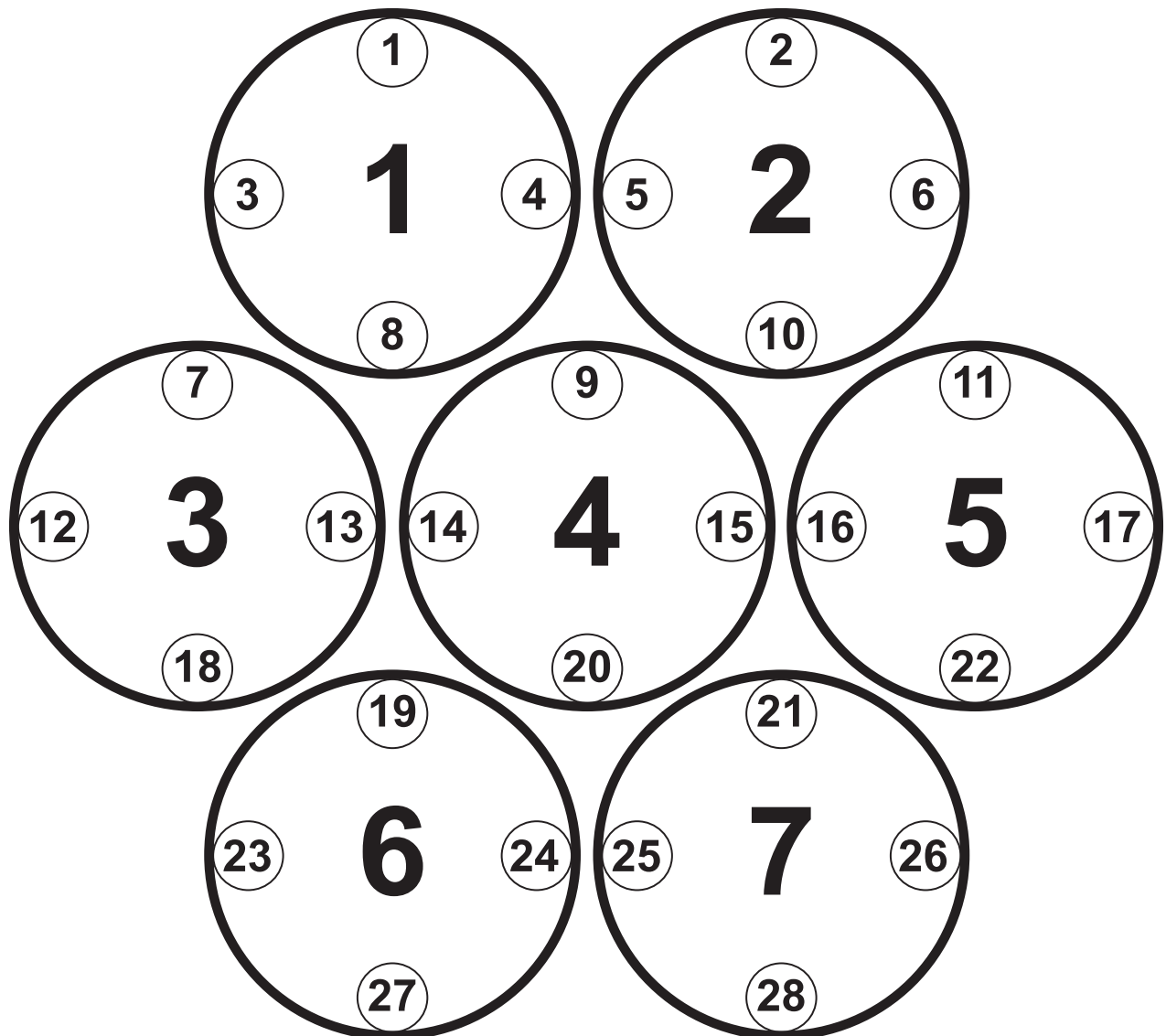

LIGHTING CONSOLE PATCHING GUIDELINES

PIXEL LAYOUT	PIXEL NUMBERS
RGBW Row 1	1, 2
RGBW Row 2	3, 4, 5
RGBW Row 3	6, 7
RGBW Column 1	3
RGBW Column 2	1, 3, 6
RGBW Column 3	1, 4, 6
RGBW Column 4	4
RGBW Column 5	2, 4, 7
RGBW Column 6	2, 5, 7
RGBW Column 7	5
Spark LED Row 1	1, 2
Spark LED Row 2	3, 4, 5, 6
Spark LED Row 3	7, 8, 9, 10, 11
Spark LED Row 4	12, 13, 14, 15, 16, 17
Spark LED Row 5	18, 19, 20, 21, 22
Spark LED Row 6	23, 24, 25, 26
Spark LED Row 7	27, 28
Spark LED Ring 1	1, 2, 6, 11, 17, 22, 26, 28, 27, 23, 18, 12, 7, 3
Spark LED Ring 2	4, 5, 10, 16, 21, 25, 24, 19, 13, 8
Spark LED Ring 3	9, 15, 20, 14

LIGHTING CONSOLE PATCHING GUIDELINES

There are also two additional parts for a primary control of the PROTEUS RAYZOR 760, which creates four separate control areas for the fixture. It is recommended to create fixture groups on the lighting controller for each area of the fixture. (see below)

Main Fixture	Primary Pan, Tilt, RGBW Color, Strobe, Dimmer, Zoom, FX Controls
RGBW Cells 1-7	Red, Green, Blue, White per each individual cell
Spark LED Main	Primary Spark LED Strobe, Dimmer
Spark LEDs 1-28	Spark LED Dimmer per each individual LED

SparkLED is not available as a mode in the fixture menu but must be provided as a console control profile for easy programming of the fixture. Use the PROTEUS RAYZOR 760 in Extended mode and patch appropriate parts of the RGBW Pixels and SparkLED fixtures on your control system to access all 80 channels.

On the lighting controller, patch the two fixture types (RGBW and SparkLED), separating the SparkLEDs into a different ID range. (see below)

RGBW Pixels for Channels 1-52

SparkLEDs for Channels 53-80

ONYX Main and Sub Fixture ID patch example below for a single PROTEUS RAYZOR 760 fixture.

ID	TYPE	ADDRESS
1.0	RGBW Pixels Main	1
1.1	Pixel 1	22
1.2	Pixel 2	26
1.3	Pixel 3	30
1.4	Pixel 4	34
1.5	Pixel 5	38
1.6	Pixel 6	42
1.7	Pixel 7	46
1.8	Spark LED Main	50

101.1	Spark LED 1	53
101.2	Spark LED 2	54
101.3	Spark LED 3	55
101.4	Spark LED 4	56
...
101.28	Spark LED 28	80

LIGHTING CONSOLE PATCHING GUIDELINES

ONLYX screen shots below illustrate Main and Sub Fixture ID patch for a single PROTEUS RAYZOR 760 fixture.

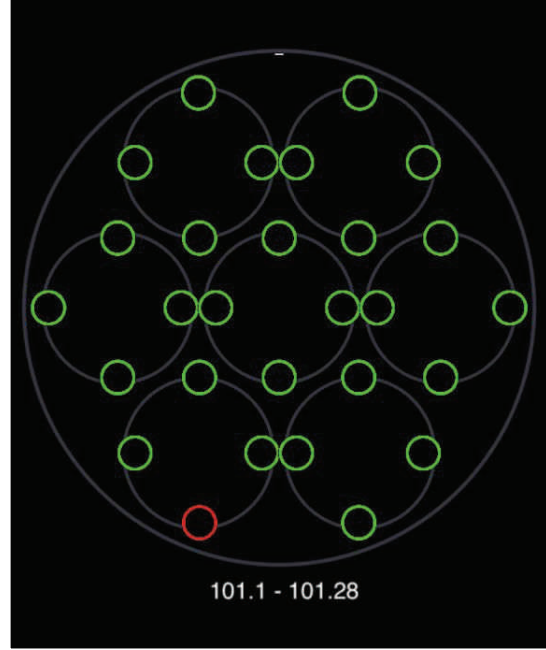
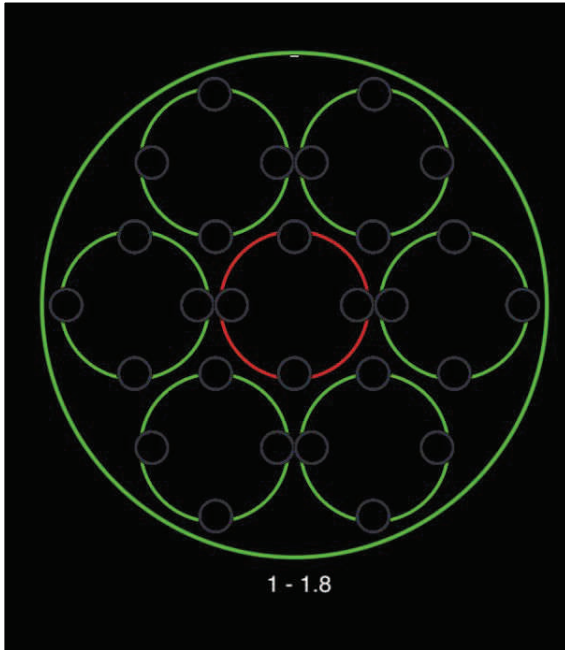

← Back

Tasks

- Patch
- Cloning
- Swap
- RDM

ID	Name	Type	Universe	Address	Invert
1		Rayzor 760 Pixel (Master)	1	1	
1.1		Rayzor 760 Pixel (Pixel 1)	Auto	Auto	
1.2		Rayzor 760 Pixel (Pixel 2)	Auto	Auto	
1.3		Rayzor 760 Pixel (Pixel 3)	Auto	Auto	
1.4		Rayzor 760 Pixel (Pixel 4)	Auto	Auto	
1.5		Rayzor 760 Pixel (Pixel 5)	Auto	Auto	
1.6		Rayzor 760 Pixel (Pixel 6)	Auto	Auto	
1.7		Rayzor 760 Pixel (Pixel 7)	Auto	Auto	
1.8		Rayzor 760 Pixel (SparkLED)	Auto	Auto	
101		Rayzor 760 SparkLED	1	51	
101.1		Rayzor 760 SparkLED (LED 1)	Auto	Auto	
101.2		Rayzor 760 SparkLED (LED 2)	Auto	Auto	
101.3		Rayzor 760 SparkLED (LED 3)	Auto	Auto	
101.4		Rayzor 760 SparkLED (LED 4)	Auto	Auto	
101.5		Rayzor 760 SparkLED (LED 5)	Auto	Auto	
101.6		Rayzor 760 SparkLED (LED 6)	Auto	Auto	
101.7		Rayzor 760 SparkLED (LED 7)	Auto	Auto	
101.8		Rayzor 760 SparkLED (LED 8)	Auto	Auto	
101.9		Rayzor 760 SparkLED (LED 9)	Auto	Auto	
101.10		Rayzor 760 SparkLED (LED 10)	Auto	Auto	
101.11		Rayzor 760 SparkLED (LED 11)	Auto	Auto	
101.12		Rayzor 760 SparkLED (LED 12)	Auto	Auto	
101.13		Rayzor 760 SparkLED (LED 13)	Auto	Auto	
101.14		Rayzor 760 SparkLED (LED 14)	Auto	Auto	
101.15		Rayzor 760 SparkLED (LED 15)	Auto	Auto	
101.16		Rayzor 760 SparkLED (LED 16)	Auto	Auto	
101.17		Rayzor 760 SparkLED (LED 17)	Auto	Auto	
101.18		Rayzor 760 SparkLED (LED 18)	Auto	Auto	
101.19		Rayzor 760 SparkLED (LED 19)	Auto	Auto	
101.20		Rayzor 760 SparkLED (LED 20)	Auto	Auto	
101.21		Rayzor 760 SparkLED (LED 21)	Auto	Auto	
101.22		Rayzor 760 SparkLED (LED 22)	Auto	Auto	
101.23		Rayzor 760 SparkLED (LED 23)	Auto	Auto	
101.24		Rayzor 760 SparkLED (LED 24)	Auto	Auto	
101.25		Rayzor 760 SparkLED (LED 25)	Auto	Auto	
101.26		Rayzor 760 SparkLED (LED 26)	Auto	Auto	
101.27		Rayzor 760 SparkLED (LED 27)	Auto	Auto	
101.28		Rayzor 760 SparkLED (LED 28)	Auto	Auto	

Multi Select OFF

Change Color

Filter

- All fixture types
- Rayzor 760 Pixel
- Rayzor 760 SparkLED

LIGHTING CONSOLE PATCHING GUIDELINES

ONYX groups example below for easier selection of a single PROTEUS RAYZOR 760 fixture.

Group Name	Group Content
All RGBW Pixels Main	1
All RGBW Pixels	1.1, 1.2, 1.3, ... 1.8
All Spark LEDs Main	1.8
All Spark LEDs	101.1, 101.2, ... 101.28

ONYX screen shot below illustrates Groups for a single PROTEUS RAYZOR 760 fixture.



The screenshot shows a grid of patching groups on a dark background with blue borders. The groups are arranged in a 3x3 grid. The first row contains groups 65, 66, and 67. The second row contains groups 80, 81, and 82. The third row contains groups 95, 96, and 97. The group names are: 65: All RGBW Pixel Main, 66: All RGBW Pixels, 80: All SparkLED Main, 81: All SparkLEDs, 95: (empty), 96: (empty), 97: (empty).

65	All RGBW Pixel Main	66	All RGBW Pixels	67
80	All SparkLED Main	81	All SparkLEDs	82
95		96		97

DMX TRAITS: MAIN FIXTURE CONTROL (V1.2.1)

Features subject to change without notice. Rotation direction (clockwise/counter-clockwise) and control of effects depends on head orientation and pan/tilt settings.							
CHANNEL				DMX VALUES	FUNCTION	FADE STATUS	DEFAULT VALUE
STANDARD	PIXELS	EXTENDED	SPARK LED				
1	1	1		000 - 255	Pan	Fade	127
2	2	2		000 - 255	Pan Fine	Fade	127
3	3	3		000 - 255	Tilt	Fade	127
4	4	4		000 - 255	Tilt Fine	Fade	127
5	5	5			Pan Rotate	Fade	0
				000 - 002	Disabled		
				003 - 126	Rotating Clockwise, fast to slow		
				127 - 129	No Rotation		
				130 - 253	Rotating Counter-Clockwise, slow to fast		
254 - 255	No Rotation						
6	6	6			Tilt Rotate	Fade	0
				000 - 002	Disabled		
				003 - 126	Rotating Clockwise, fast to slow		
				127 - 129	No Rotation		
				130 - 253	Rotating Counter-Clockwise, slow to fast		
254 - 255	No Rotation						
7	7	7			CTC	Fade	0
				000 - 010	Disabled		
				011 - 171	Color Temperature, 2000K to 10,000K in 100K steps (see CTC Table section of this manual)		
				172 - 255	10,000K		
8	8	8			Color Wheel	Snap	0
				000 - 009	Open		
				010 - 014	Red		
				015 - 019	Red Orange		
				020 - 024	Light Amber		
				025 - 029	Yellow Amber		
				030 - 034	Greenish Yellow		
				035 - 039	Light Yellow Green		
				040 - 044	Dark Yellow Green		
				045 - 049	Green		
				050 - 054	Teal		
				055 - 059	Cyan		
				060 - 064	Light Blue		
				065 - 069	Aqua		
				070 - 074	Dark Aqua		
				075 - 079	Green Blue		
				080 - 084	Light Lavender		
				085 - 089	Dark Purple		
				090 - 094	Medium Purple		
				095 - 099	Mid Rose		
				100 - 104	Mauve		
				105 - 109	Nice Magenta		
				110 - 114	Warm Magenta		
				115 - 119	Light Red		
120 - 124	Straw						
125 - 129	Dark CTB						
130 - 134	Light Green						
135 - 139	Purple						
140 - 144	Lighter Purple						
145 - 149	Pink						
150 - 154	Rose						
155 - 159	Rose						
160 - 174	Not in use						
175 - 179	Open						

DMX TRAITS: MAIN FIXTURE CONTROL

CHANNEL				DMX VALUES	FUNCTION	FADE STATUS	DEFAULT VALUE
STANDARD	PIXELS	EXTENDED	SPARK LED				
8	8	8			Color Scroll	Snap	0
				180 - 201	Clockwise, fast to slow		
				202 - 207	Stop		
				208 - 229	Counter-Clockwise, slow to fast		
				230 - 234	Open		
					Random Slots		
				235 - 239	Fast		
				240 - 244	Medium		
				245 - 249	Slow		
				250 - 255	Open		
9	9	9			Strobe	Snap	50
				000 - 031	Shutter Closed		
				032 - 063	Shutter Open		
				064 - 095	Strobe, slow to fast		
				096 - 127	Fast Close, Slow Open		
				128 - 159	Fast Open, Slow Close		
				160 - 191	Pulse Effects		
				192 - 223	Random Strobe, slow to fast		
				224 - 255	Shutter Open		
				10	10		
11	11	11		000 - 255	Dimmer Fine	Fade	0
12	12	12			Dim Modes	Snap	0
				000 - 020	Standard		
				021 - 040	Stage		
				041 - 060	TV		
				061 - 080	Architectural		
				081 - 100	Theatre		
				101 - 120	Stage 2		
					Dimmer Delay Time		
				121	0 s		
				122	0.1 s		
				123	0.2 s		
				124	0.3 s		
				125	0.4 s		
				126	0.5 s		
				127	0.6 s		
				128	0.7 s		
				129	0.8 s		
				130	0.9 s		
				131	1.0 s		
				132	1.5 s		
				133	2.0 s		
				134	3.0 s		
				135	4.0 s		
				136	5.0 s		
				137	6.0 s		
				138	7.0 s		
139	8.0 s						
140	9.0 s						
141	10.0 s						
	142 - 255	Idle					

DMX TRAITS: MAIN FIXTURE CONTROL

CHANNEL				DMX VALUES	FUNCTION	FADE STATUS	DEFAULT VALUE
STANDARD	PIXELS	EXTENDED	SPARK LED				
13	13	13			Zoom	Fade	128
				000 - 215	Zoom, wide to narrow		
				215 - 255	Overdrive, minimum to maximum		
	14	14		000 - 255	Zoom Fine	Fade	0
	15	15			Pan / Tilt Speed	Snap	0
				000 - 225	Max to Min Speed		
				226 - 235	Blackout when pan / tilt moves		
				236 - 245	Blackout when all wheels change		
				246 - 255	No function		
14	16	16			Control	Snap	0
				000 - 010	Idle		
				011 - 012	Pan Tilt Shortest Path		
				013 - 014	Pan Tilt Continue Path		
				015 - 016	Pan Range 540		
				017 - 018	Pan Range 360		
				019 - 020	Tilt Range 270		
				021 - 022	Tilt Range 360		
				023 - 039	Idle		
				040 - 059	Fan Mode Silent		
				060 - 079	Fan Mode Auto		
				080 - 084	Reset All		
				085 - 087	Reset Movement		
				088 - 091	Reset Zoom		
				092 - 099	Idle		
					Refresh Rate (Hz)		
				100	900		
				101	910		
				102	920		
				103	930		
				104	940		
				105	950		
				106	960		
				107	970		
				108	980		
				109	990		
				110	1000		
				111	1010		
				112	1020		
				113	1030		
				114	1040		
				115	1050		
				116	1060		
				117	1070		
				118	1080		
119	1090						
120	1100						
121	1110						
122	1120						
123	1130						
124	1140						
125	1150						
126	1160						
127	1170						
128	1180						
129	1190						
130	1200						

DMX TRAITS: MAIN FIXTURE CONTROL

CHANNEL				DMX VALUES	FUNCTION	FADE STATUS	DEFAULT VALUE
STANDARD	PIXELS	EXTENDED	SPARK LED				
14	16	16			Refresh Rate (Hz) (continued)	Snap	0
				131	1210		
				132	1220		
				133	1230		
				134	1240		
				135	1250		
				136	1260		
				137	1270		
				138	1280		
				139	1290		
				140	1300		
				141	1310		
				142	1320		
				143	1330		
				144	1340		
				145	1350		
				146	1360		
				147	1370		
				148	1380		
				149	1390		
				150	1400		
				151	1410		
				152	1420		
				153	1430		
				154	1440		
				155	1450		
				156	1460		
				157	1470		
				158	1480		
				159	1490		
				160	1500		
				161	2500		
				162	4000		
				163	5000		
164	6000						
165	10000						
166	15000						
167	20000						
168	25000						
169 - 200	Idle						
				ADDED WITH SOFTWARE UPDATE 1.2.2			
169 - 192	Idle						
193 - 194	Hibernate Off						
195 - 196	Hibernate						
197 - 198	Home Position Before Power Off						
199 - 200	Home Position Off						
201 - 210	Dimmer Curve Linear (default)						
211 - 220	Dimmer Curve Square						
221 - 230	Dimmer Curve Inverse Square						
231 - 240	Dimmer Curve S-Curve						
241 - 255	Idle						

DMX TRAITS: MAIN FIXTURE CONTROL

CHANNEL				DMX VALUES	FUNCTION	FADE STATUS	DEFAULT VALUE
STANDARD	PIXELS	EXTENDED	SPARK LED				
15	17	17		000 - 255	RGBW FX Table , FX selection 1 - 255 (see RGBW FX Table section of this manual)	Snap	0
16	18	18		000 - 126	RGBW FX Speed Rev fast to slow	Fade	160
				127 - 128	Stop		
				129 - 255	slow to fast		
17	19	19		000 - 255	Spark LED FX Selection , 1 - 255 (see Spark LED FX Table section of this manual)	Snap	0
18	20	20			Spark LED FX Speed	Fade	160
				000 - 126	Rev, fast to slow		
				127 - 128	Stop		
19	21	21			FX Offset	Snap	0
				000	No Sync		
				001 - 035	Fixture offset, 10 degrees to 350 degrees		
				036	Synchronized		
				037 - 100	No Function		
				101 - 120	Random Fixtures		
				121 - 140	Random Duration		
141 - 255	Random Pixels						
20	22	22		000 - 255	Red , 0% to 100%	Fade	255
21	23	23		000 - 255	Green , 0% to 100%	Fade	255
22	24	24		000 - 255	Blue , 0% to 100%	Fade	255
23	25	25		000 - 255	White , 0% to 100%	Fade	255
	26	26		000 - 255	Red 2 , 0% to 100%	Fade	255
	27	27		000 - 255	Green 2 , 0% to 100%	Fade	255
	28	28		000 - 255	Blue 2 , 0% to 100%	Fade	255
	29	29		000 - 255	White 2 , 0% to 100%	Fade	255
	30	30		000 - 255	Red 3 , 0% to 100%	Fade	255
	31	31		000 - 255	Green 3 , 0% to 100%	Fade	255
	32	32		000 - 255	Blue 3 , 0% to 100%	Fade	255
	33	33		000 - 255	White 3 , 0% to 100%	Fade	255
	34	34		000 - 255	Red 4 , 0% to 100%	Fade	255
	35	35		000 - 255	Green 4 , 0% to 100%	Fade	255
	36	36		000 - 255	Blue 4 , 0% to 100%	Fade	255
	37	37		000 - 255	White 4 , 0% to 100%	Fade	255
	38	38		000 - 255	Red 5 , 0% to 100%	Fade	255
	39	39		000 - 255	Green 5 , 0% to 100%	Fade	255
	40	40		000 - 255	Blue 5 , 0% to 100%	Fade	255
	41	41		000 - 255	White 5 , 0% to 100%	Fade	255
	42	42		000 - 255	Red 6 , 0% to 100%	Fade	255
	43	43		000 - 255	Green 6 , 0% to 100%	Fade	255
	44	44		000 - 255	Blue 6 , 0% to 100%	Fade	255
	45	45		000 - 255	White 6 , 0% to 100%	Fade	255
	46	46		000 - 255	Red 7 , 0% to 100%	Fade	255
	47	47		000 - 255	Green 7 , 0% to 100%	Fade	255
	48	48		000 - 255	Blue 7 , 0% to 100%	Fade	255
	49	49		000 - 255	White 7 , 0% to 100%	Fade	255

DMX TRAITS: SPARK LED CONTROL

NOTE: Spark LED is not available as a mode in the fixture menu, but must be provided as a console control profile for easy programming of the fixture. Use this fixture in Extended mode and patch appropriate parts of the RGBW pixels and Spark LED fixtures on your control system to access all 80 channels. See the **Lighting Console Patch Guidelines** section of this manual for further instructions.

CHANNEL				DMX VALUES	FUNCTION	FADE STATUS	DEFAULT VALUE
STANDARD	PIXELS	EXTENDED	SPARK LED				
24	50	50			Strobe	Snap	50
				000 - 031	Shutter Closed		
				032 - 063	Shutter Open		
				064 - 095	Strobe, slow to fast		
				096 - 127	Fast Close, Slow Open		
				128 - 159	Fast Open, Slow Close		
				160 - 191	Pulse Effects		
				192 - 223	Random Strobe All, slow to fast		
			224 - 255	Random Strobe Pixels, slow to fast			
25	51	51		000 - 255	Dimmer, 0% to 100%	Fade	0
	52	52		000 - 255	Dimmer Fine	Fade	0
		53	1	000 - 255	Spark LED #1 Dimmer, 0% to 100%	Fade	255
		54	2	000 - 255	Spark LED #2 Dimmer, 0% to 100%	Fade	255
		55	3	000 - 255	Spark LED #3 Dimmer, 0% to 100%	Fade	255
		56	4	000 - 255	Spark LED #4 Dimmer, 0% to 100%	Fade	255
		57	5	000 - 255	Spark LED #5 Dimmer, 0% to 100%	Fade	255
		58	6	000 - 255	Spark LED #6 Dimmer, 0% to 100%	Fade	255
		59	7	000 - 255	Spark LED #7 Dimmer, 0% to 100%	Fade	255
		60	8	000 - 255	Spark LED #8 Dimmer, 0% to 100%	Fade	255
		61	9	000 - 255	Spark LED #9 Dimmer, 0% to 100%	Fade	255
		62	10	000 - 255	Spark LED #10 Dimmer, 0% to 100%	Fade	255
		63	11	000 - 255	Spark LED #11 Dimmer, 0% to 100%	Fade	255
		64	12	000 - 255	Spark LED #12 Dimmer, 0% to 100%	Fade	255
		65	13	000 - 255	Spark LED #13 Dimmer, 0% to 100%	Fade	255
		66	14	000 - 255	Spark LED #14 Dimmer, 0% to 100%	Fade	255
		67	15	000 - 255	Spark LED #15 Dimmer, 0% to 100%	Fade	255
		68	16	000 - 255	Spark LED #16 Dimmer, 0% to 100%	Fade	255
		69	17	000 - 255	Spark LED #17 Dimmer, 0% to 100%	Fade	255
		70	18	000 - 255	Spark LED #18 Dimmer, 0% to 100%	Fade	255
		71	19	000 - 255	Spark LED #19 Dimmer, 0% to 100%	Fade	255
		72	20	000 - 255	Spark LED #20 Dimmer, 0% to 100%	Fade	255
		73	21	000 - 255	Spark LED #21 Dimmer, 0% to 100%	Fade	255
		74	22	000 - 255	Spark LED #22 Dimmer, 0% to 100%	Fade	255
		75	23	000 - 255	Spark LED #23 Dimmer, 0% to 100%	Fade	255
		76	24	000 - 255	Spark LED #24 Dimmer, 0% to 100%	Fade	255
		77	25	000 - 255	Spark LED #25 Dimmer, 0% to 100%	Fade	255
		78	26	000 - 255	Spark LED #26 Dimmer, 0% to 100%	Fade	255
		79	27	000 - 255	Spark LED #27 Dimmer, 0% to 100%	Fade	255
		80	28	000 - 255	Spark LED #28 Dimmer, 0% to 100%	Fade	255

COLOR TEMPERATURE CONTROL TABLE





COLOR TEMP	DMX VALUE	COLOR TEMP	DMX VALUE	COLOR TEMP	DMX VALUE	COLOR TEMP	DMX VALUE
2000	011	4150	054	6300	097	8450	140
2050	012	4200	055	6350	098	8500	141
2100	013	4250	056	6400	099	8550	142
2150	014	4300	057	6450	100	8600	143
2200	015	4350	058	6500	101	8650	144
2250	016	4400	059	6550	102	8700	145
2300	017	4450	060	6600	103	8750	146
2350	018	4500	061	6650	104	8800	147
2400	019	4550	062	6700	105	8850	148
2450	020	4600	063	6750	106	8900	149
2500	021	4650	064	6800	107	8950	150
2550	022	4700	065	6850	108	9000	151
2600	023	4750	066	6900	109	9050	152
2650	024	4800	067	6950	110	9100	153
2700	025	4850	068	7000	111	9150	154
2750	026	4900	069	7050	112	9200	155
2800	027	4950	070	7100	113	9250	156
2850	028	5000	071	7150	114	9300	157
2900	029	5050	072	7200	115	9350	158
2950	030	5100	073	7250	116	9400	159
3000	031	5150	074	7300	117	9450	160
3050	032	5200	075	7350	118	9500	161
3100	033	5250	076	7400	119	9550	162
3150	034	5300	077	7450	120	9600	163
3200	035	5350	078	7500	121	9650	164
3250	036	5400	079	7550	122	9700	165
3300	037	5450	080	7600	123	9750	166
3350	038	5500	081	7650	124	9800	167
3400	039	5550	082	7700	125	9850	168
3450	040	5600	083	7750	126	9900	169
3500	041	5650	084	7800	127	9950	170
3550	042	5700	085	7850	128	10000	171
3600	043	5750	086	7900	129		
3650	044	5800	087	7950	130		
3700	045	5850	088	8000	131		
3750	046	5900	089	8050	132		
3800	047	5950	090	8100	133		
3850	048	6000	091	8150	134		
3900	049	6050	092	8200	135		
3950	050	6100	093	8250	136		
4000	051	6150	094	8300	137		
4050	052	6200	095	8350	138		
4100	053	6250	096	8400	139		

FX GENERATOR GUIDELINES

Selection and control of the integrated FX on the PROTUES RAYZOR 760 is found in the Main Fixture section. All FX are available even in the smallest DMX control modes.

DMX VALUES	FUNCTION
000 - 255	RGBW FX Selection, 1 - 255 (see RGBW FX Table)
	RGBW FX Speed
000 - 126	Rev, fast to slow
127 - 128	Stop
129 - 255	Slow to fast
000 - 255	Spark LED FX Selection, 1 - 255, (see Spark LED FX Table)
	Spark LED FX Speed
000 - 126	Rev, fast to slow
127 - 128	Stop
129 - 255	Slow to fast

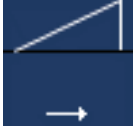
FX for RGBW and SparkLED contain a selection channel to recall the desired pattern. The pattern direction and speed is then adjusted using the associated Speed channels. FX can run forward or reverse and can also be frozen at any time by using "Stop". The FX tables show the available patterns which are grouped for easier browsing. The first 10 DMX steps of the FX channel are used to change the type of curve for smooth or stepped FX. Once a curve is selected, it will be used for all FX recalled afterwards. When programming curves for fixtures, the user must ensure to change the curve first before selecting the pattern. The fixture defaults to the Sinewave pattern after every power cycle.

Sinewave (default)		
Step		
Sawtooth		Ramp Up
Ramp Up		
Ramp Down		

FX GENERATOR GUIDELINES

In addition to FX direction and speed control, a Sync channel allows to offset or randomize the fixtures or the FX steps.

DMX VALUES	FUNCTION
	FX Offset
000	No Sync
001 - 035	Fixture Offset, 10 degrees to 350 degrees
036	Synchronized
037 - 100	No Function
101 - 120	Random Fixture Offset
121 - 140	Random Pixel Order
141 - 255	Random Steps

A full FX cycle is 360 degrees, and the fixture offsets can be set in 10-degree increments. Offsetting a fixture by 180 would mean it is exactly halfway ahead through the FX cycle.

Three randomization options are provided:

Random Fixture Offset

Every fixture randomly selects any of the 36 offset points. It will then use this until the offset is changed or random offset is selected again.

Random Pixel Order

The actual FX steps are randomized. This shuffling of the fixture order is done once, then the fixture will use this shuffled order across all FX until changed.







Random Steps

Every step is randomly chosen every time, giving the most random sequence possible.

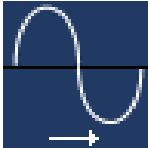
To reshuffle the randomization, set the channel to Idle and reselect the desired random option.

The FX system of the PROTEUS RAYZOR 760 allows many different combinations by changing the curves, offsets and speed parameters. The RGBW and SparkLED systems are separate, and by adjusting color, dimming and strobe channels there are endless creative designs possible.

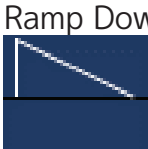
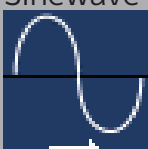
RGBW FX TABLE

TYPE	SLOT	DMX VALUES	NAME	FX ADJUSTMENT	
Waveform	0	000	Off		
	1	001	Sinewave (default) 		
	2	002	Step 		
	3	003	Sawtooth 		
	4	004	Ramp Up 		
	5	005	Ramp Down 		
	6-10	006 - 010	No Function		
	REVISED WITH SOFTWARE UPDATE VERSION 1.2.2				
	0	000	Off		
	1	001	Sinewave Cross (default) 		
2	002	Sinewave Full 			

RGBW FX TABLE

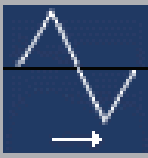
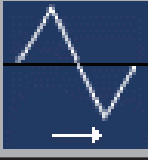
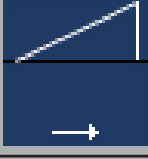
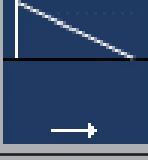
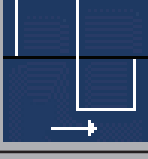
TYPE	SLOT	DMX VALUES	NAME	FX ADJUSTMENT
REVISED WITH SOFTWARE UPDATE VERSION 1.2.2				
Waveform	3	003	Sawtooth Cross 	
	4	004	Sawtooth Full 	
	5	005	Ramp Up 	
	6	006	Ramp Down 	
	7	007	Step 	
	8-10	008 - 010	No Function	
	Intensity	11	011	Single
12		012	Single Bounce	Reverse, Stop, Forward
13		013	Snake	Reverse, Stop, Forward
14		014	Snake Bounce	Reverse, Stop, Forward
15		015	Rows	Reverse, Stop, Forward
16		016	Rows Bounce	Reverse, Stop, Forward
17		017	Column	Reverse, Stop, Forward
18		018	Column Bounce	Reverse, Stop, Forward
19		019	Columns 2	Reverse, Stop, Forward
20		020	Slash	Reverse, Stop, Forward
21		021	Backslash	Reverse, Stop, Forward
22		022	Slash Back	Reverse, Stop, Forward
23	023	<>	Reverse, Stop, Forward	

RGBW FX TABLE

TYPE	SLOT	DMX VALUES	NAME	FX ADJUSTMENT
Intensity	24	024	><	Reverse, Stop, Forward
	25	025	>>	Reverse, Stop, Forward
	26	026	<<	Reverse, Stop, Forward
	27	027	Rotating Bar	Reverse, Stop, Forward
	28	028	Rotating Dot	Reverse, Stop, Forward
	29	029	Rotating 2 Dot	Reverse, Stop, Forward
	30	030	Ring 2 Cell	Reverse, Stop, Forward
	31	031	Ring 2 Cell Overlap	Reverse, Stop, Forward
	32	032	Ring 3 Cell Blend	Reverse, Stop, Forward
	33	033	Ring - Center Fade	Reverse, Stop, Forward
	34	034	X-Bar	Reverse, Stop, Forward
	35	035	Diagonals	Reverse, Stop, Forward
	36	036	Arrow Left	Reverse, Stop, Forward
	37	037	Arrow Right	Reverse, Stop, Forward
	38	038	2 Pixels	Reverse, Stop, Forward
	39	039	3 Pixels	Reverse, Stop, Forward
	40	040	4 Pixels	Reverse, Stop, Forward
	41	041	1, 2, 3, 4 Pixels	Reverse, Stop, Forward
	42	042	Ring Build	Reverse, Stop, Forward
	43	043	Ring Build Erase	Reverse, Stop, Forward
	44	044	Ring Build Erase 2	Reverse, Stop, Forward
	45	045	Chase 1	Reverse, Stop, Forward
	46	046	Chase 2	Reverse, Stop, Forward
	47	047	Chase 3	Reverse, Stop, Forward
	48	048	Chase 4	Reverse, Stop, Forward
	49	049	Chase 5	Reverse, Stop, Forward
	50	050	Chase 6	Reverse, Stop, Forward
	51	051	Chase 7	Reverse, Stop, Forward
	52	052	Chase 8	Reverse, Stop, Forward
	53	053	Chase 9	Reverse, Stop, Forward
	54	054	Chase 10	Reverse, Stop, Forward
	55-59	055 - 059	No Function	No Function
	60	060	Center Chase	Reverse, Stop, Forward
61	061	Center Chase 2	Reverse, Stop, Forward	
62-100	062 - 100	No Function	No Function	



RGBW FX TABLE

TYPE	SLOT	DMX VALUES	NAME	FX ADJUSTMENT
Intensity (continued)	REVISED WITH SOFTWARE UPDATE VERSION 1.2.2			
	55	055	Center Chase	Reverse, Stop, Forward
	56	056	Center Chase 2	Reverse, Stop, Forward
	57	057	Alternate	Reverse, Stop, Forward
	58	058	Burst Spark LED	Reverse, Stop, Forward
	59	059	Burst RGBW	Reverse, Stop, Forward
	60	060	Strobe Alternate	Reverse, Stop, Forward
	62	062	Lens/Spark LED Alternate	Reverse, Stop, Forward
	66-100	066 - 100	No Function	No Function
Static Patterns	101	101	Top 2	Disabled
	102	102	Center 3	Disabled
	103	103	Bottom 2	Disabled
	104	104	Top and Bottom	Disabled
	105	105	X	Disabled
	106	106	Ring	Disabled
	107	107	Center Dot	Disabled
	108	108	Slash	Disabled
	109	109	Backslash	Disabled
	110	110	Arrow Left	Disabled
	111	111	Arrow Right	Disabled
	112	112	<	Disabled
	113	113	>	Disabled
	114-255	114 - 255	No Function	No Function
Color	REVISED WITH SOFTWARE UPDATE VERSION 1.2.2			
	131	131	RGBW Cells	Reverse, Stop, Forward
	132	132	RGBWCMY Cells	Reverse, Stop, Forward
	133	133	Color Wheel Cells	Reverse, Stop, Forward
	134	134	RGBW Rows	Reverse, Stop, Forward
	135	135	RGBWCMY Rows	Reverse, Stop, Forward
	136	136	Color Wheel Rows	Reverse, Stop, Forward
	137	137	RGBW Columns	Reverse, Stop, Forward
	138	138	RGBWCMY Columns	Reverse, Stop, Forward
	139	139	Color Wheel Columns	Reverse, Stop, Forward
	140	140	RGBW Single Row	Reverse, Stop, Forward
	141	141	RGBWCMY Single Row	Reverse, Stop, Forward
	142	142	Color Wheel Single Row	Reverse, Stop, Forward

RGBW FX TABLE

TYPE	SLOT	DMX VALUES	NAME	FX ADJUSTMENT
Color (continued)	REVISED WITH SOFTWARE UPDATE VERSION 1.2.2			
	143	143	RGBW Single Columns	Reverse, Stop, Forward
	144	144	RGBWCMY Single Columns	Reverse, Stop, Forward
	145	145	Color Wheel Single Columns	Reverse, Stop, Forward
	146	146	RGB Rows	Reverse, Stop, Forward
	147	147	RGB Columns	Reverse, Stop, Forward
	148	148	Red White Cells	Reverse, Stop, Forward
	149	149	Green White Cells	Reverse, Stop, Forward
	150	150	Blue White Cells	Reverse, Stop, Forward
	151	151	Red Green Cells	Reverse, Stop, Forward
	152	152	Red Blue Cells	Reverse, Stop, Forward
	153	153	Blue Green Cells	Reverse, Stop, Forward
	154	154	Ring - Center Mix to Color Wheel	Reverse, Stop, Forward
	155	155	Random White Cell	Reverse, Stop, Forward
	156	156	Random White Row	Reverse, Stop, Forward
	157	157	Random White Column	Reverse, Stop, Forward
	158	158	White Flash	Reverse, Stop, Forward
	159	159	Red Flash	Reverse, Stop, Forward
	160	160	Green Flash	Reverse, Stop, Forward
	161	161	Blue Flash	Reverse, Stop, Forward
162	162	Color Wheel Flash	Reverse, Stop, Forward	
163	163	Alternate Color	Reverse, Stop, Forward	
164-255	164 - 255	No Function	No Function	

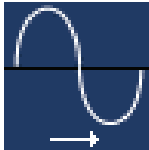
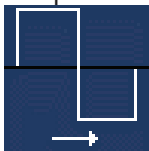
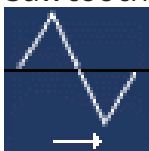
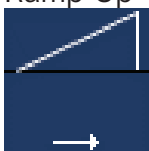
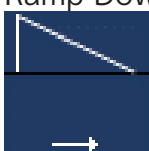
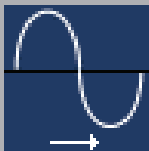
RGBW FX TABLE

TYPE	SLOT	DMX VALUES	NAME	FX ADJUSTMENT	
Waveform	0	000	Off		
	1	001	Sinewave (default) 		
	2	002	Step 		
	3	003	Sawtooth 		
	4	004	Ramp Up 		
	5	005	Ramp Down 		
	6-10	006 - 010	No Function		
	REVISED WITH SOFTWARE UPDATE VERSION 1.1.1				
	0	000	Off		
	1	001	Sinewave Cross (default) 		
	2	002	Sinewave Full 		

RGBW FX TABLE

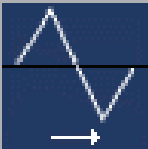
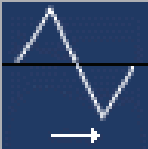
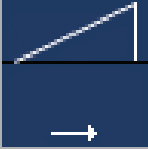
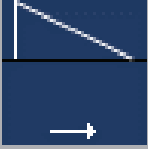
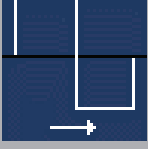
TYPE	SLOT	DMX VALUES	NAME	FX ADJUSTMENT
Waveform (continued)	REVISED WITH SOFTWARE UPDATE VERSION 1.1.1			
	3	003	Sawtooth Cross 	
	4	004	Sawtooth Full 	
	5	005	Ramp Up 	
	6	006	Ramp Down 	
	7	007	Step 	
	8-10	008 - 010	No Function	
Spark LED FX	11	011	Starfield	Reverse, Stop, Forward
	12	012	1 Pixel	Reverse, Stop, Forward
	13	013	2 Pixels	Reverse, Stop, Forward
	14	014	3 Pixels	Reverse, Stop, Forward
	15	015	4 Pixels	Reverse, Stop, Forward
	16	016	5 Pixels	Reverse, Stop, Forward
	17	017	7 Pixels	Reverse, Stop, Forward
	18	018	14 Pixels	Reverse, Stop, Forward
	19	019	Single Row	Reverse, Stop, Forward
	20	020	3 Rows	Reverse, Stop, Forward
	21	021	Single Column	Reverse, Stop, Forward
22	022	3 Columns	Reverse, Stop, Forward	

RGBW FX TABLE

TYPE	SLOT	DMX VALUES	NAME	FX ADJUSTMENT
Spark LED FX (continued)	23	023	Pixel Ring Chase	Reverse, Stop, Forward
	24	024	Pixel Row Chase	Reverse, Stop, Forward
	25	025	Pixel Ring Chase 2	Reverse, Stop, Forward
	26	026	Center Out	Reverse, Stop, Forward
	27	027	Fireworks	Reverse, Stop, Forward
	28	028	Ring	Reverse, Stop, Forward
	29	029	Row	Reverse, Stop, Forward
	30	030	Snake	Reverse, Stop, Forward
	31-90	031 - 090	No Function	No Function
Spark LED Lens Combos	91-100	091 - 100	No Function	No Function
Full Lens Patterns	101	101	Single	Reverse, Stop, Forward
	102	102	Single Bounce	Reverse, Stop, Forward
	103	103	Snake	Reverse, Stop, Forward
	104	104	Snake Bounce	Reverse, Stop, Forward
	105	105	Rows	Reverse, Stop, Forward
	106	106	Rows Bounce	Reverse, Stop, Forward
	107	107	Column	Reverse, Stop, Forward
	108	108	Column Bounce	Reverse, Stop, Forward
	109	109	Columns 2	Reverse, Stop, Forward
	110	110	Slash	Reverse, Stop, Forward
	111	111	Backslash	Reverse, Stop, Forward
	112	112	Slash Back	Reverse, Stop, Forward
	113	113	<>	Reverse, Stop, Forward
	114	114	><	Reverse, Stop, Forward
	115	115	>>	Reverse, Stop, Forward
	116	116	<<	Reverse, Stop, Forward
	117	117	Rotating Bar	Reverse, Stop, Forward
	118	118	Rotating Dot	Reverse, Stop, Forward
	119	119	Rotating 2 Dot	Reverse, Stop, Forward
	120	120	Ring 2 Cell	Reverse, Stop, Forward
	121	121	Ring 2 Cell Overlap	Reverse, Stop, Forward
	122	122	Ring 3 Cell Blend	Reverse, Stop, Forward
	123	123	Ring - Center Fade	Reverse, Stop, Forward
	124	124	X-Bar	Reverse, Stop, Forward
	125	125	Diagonals	Reverse, Stop, Forward
	126	126	Arrow Left	Reverse, Stop, Forward

RGBW FX TABLE

TYPE	SLOT	DMX VALUES	NAME	FX ADJUSTMENT
Full Lens Patterns (continued)	127	127	Arrow Right	Reverse, Stop, Forward
	128	128	2 Pixels	Reverse, Stop, Forward
	129	129	3 Pixels	Reverse, Stop, Forward
	130	130	4 Pixels	Reverse, Stop, Forward
	131	131	1, 2, 3, 4 Pixels	Reverse, Stop, Forward
	132	132	Ring Build	Reverse, Stop, Forward
	133	133	Ring Build Erase	Reverse, Stop, Forward
	134	134	Ring Build Erase 2	Reverse, Stop, Forward
	135	135	Chase 1	Reverse, Stop, Forward
	136	136	Chase 2	Reverse, Stop, Forward
	137	137	Chase 3	Reverse, Stop, Forward
	138	138	Chase 4	Reverse, Stop, Forward
	139	139	Chase 5	Reverse, Stop, Forward
	140	140	Chase 6	Reverse, Stop, Forward
	141	141	Chase 7	Reverse, Stop, Forward
	142	142	Chase 8	Reverse, Stop, Forward
	143	143	Chase 9	Reverse, Stop, Forward
	144	144	Chase 10	Reverse, Stop, Forward
	145	145	Center Chase	Reverse, Stop, Forward
146	146	Center Chase 2	Reverse, Stop, Forward	
	147-200	147 - 200	No Function	No Function
Full Lens Static Patterns	201	201	Top 2	Disabled
	202	202	Center 3	Disabled
	203	203	Bottom 2	Disabled
	204	204	Top and Bottom	Disabled
	205	205	X	Disabled
	206	206	Ring	Disabled
	207	207	Center Dot	Disabled
	208	208	Slash	Disabled
	209	209	Backslash	Disabled
	210	210	Arrow Left	Disabled
	211	211	Arrow Right	Disabled
	212	212	<	Disabled
	213	213	>	Disabled
		214-255	214 - 255	No Function

CONTINUED ON NEXT PAGE

RGBW FX TABLE

TYPE	SLOT	DMX VALUES	NAME	FX ADJUSTMENT
Spark LED Pattern	226	226	Row 1	Disabled
	227	227	Row 2	Disabled
	228	228	Row 3	Disabled
	229	229	Row 4	Disabled
	230	230	Row 5	Disabled
	231	231	Row 6	Disabled
	232	232	Row 7	Disabled
	233	233	Column 1	Disabled
	234	234	Column 2	Disabled
	235	235	Column 3	Disabled
	236	236	Column 4	Disabled
	237	237	Column 5	Disabled
	238	238	Column 6	Disabled
	239	239	Column 7	Disabled
	240	240	Ring 1	Disabled
	241	241	Ring 2	Disabled
	242	242	Ring 3	Disabled
	243-255	243 - 255	No Function	No Function

ERROR CODES

When power is applied, the unit will automatically enter a "Reset/Test" mode, which brings all the internal motors to a home position. If there is an internal problem with one or more of the motors, an error code will flash on the display screen. For example, when the display shows "Pan Er" it means there is some type of error with the Pan motor. If there are multiple errors during the start-up process they will all flash in the display. For example: if the fixtures has Pan, Tilt, and Zoom errors all at the same time, you will see the error message "Pan Er", "Tilt Er", and "Zoom Er" flash in sequence 5 times.

If an error occurs during the initial start-up procedure, the fixture will self-generate a second reset signal and try to realign all the motors and correct the errors. If the error persists after a second attempt, a third attempt will be made. If after a third attempt all the errors have not been corrected, the fixture will make the following determinations:

- **3 or More Errors** - The fixture cannot function properly with three or more errors, and therefore the fixture will place itself in stand-by mode until subsequent repairs can be made.
- **Less Than 3 Errors** - The fixture has less than 3 errors, and therefore most other functions will work properly. The fixture will attempt to operate normally until the errors can be corrected by a technician. The errors in question will remain flashing in the display as a reminder of internal errors.

Note: Error Codes are subject to change without any prior written notice.	
ERROR CODES	DESCRIPTION
Pan Er	Movement is not located in the default position after the reset. This message will appear after a fixture reset if the magnetic-indexing circuit malfunctions (sensor failed, or magnet is missing) or there is a motor failure (defective motor or a defective motor IC drive on the main PCB). This error may also be displayed if the head/yoke was blocked during a reset function.
Tilt Er	
Zoom Er	Movement is not located in the default position after the reset. This message will appear after a fixture reset if the magnetic-indexing circuit malfunctions (sensor failed, or magnet is missing) or there is a motor failure (defective motor or a defective motor IC drive on the main PCB).

SPECIFICATIONS

SOURCE

(7) 60W Osram RGBW LEDs

(28) 2W White SparkLED™

50,000 Hour Average LED Life*

*Test lab conditions. May vary depending on several factors including but not limited to: Environmental Conditions, Power/Voltage, Usage Patterns (On-Off Cycling), Control, and Dimming.

PHOTOMETRIC DATA

7,200 Total Lumen Output

CRI 80

Zoom Range 5° - 77°

Beam Angle 5.4° - 56.4°

Field Angle 8.1° - 74°

EFFECTS

Motorized Zoom

Linear Color Temperature Presets (2700-8000K)

RGBW Color Mixing and Pixel Control

White SparkLED Lens Effect

Color Presets and Macros

Electronic Strobe and Variable Dimming Curves

16-bit Dimming

Pan Angle: 540°/630°

Tilt Angle: 270°/360°

CONTROL / CONNECTIONS

3 DMX Channel Modes (25 / 52 / 80 channels)

360° Continuous Pan and Tilt Movement

DMX Adjustable Refresh Rate (900 - 25000 Hz)

(6) Button Touch Panel

Full Color 180° Reversible LCD Menu Display

RDM Support IP65 5pin XLR DMX In/Out

IP65 RJ45 Ethernet In/Out (Art-Net, sACN)

IP65 Locking Power Cable In

With Wired Digital Communication Network

SIZE / WEIGHT

Length: 14.31 in (363.4mm)

Width: 10.24 in (259.97mm)

Height: 19.43 in (493.44mm)

Center-to-Center: 16.6" (421.5mm)

Weight: 41.0 lbs. (18.6kg)

ELECTRICAL / THERMAL

AC 100-240V 50/60Hz

700W Max Power Consumption

BTU/hr (+/- 10%) 2387

APPROVALS / RATINGS

CE | cETLus | IP65



Specifications and documentation subject to change without notice.

DIMENSIONAL DRAWINGS

DRAWINGS NOT TO SCALE

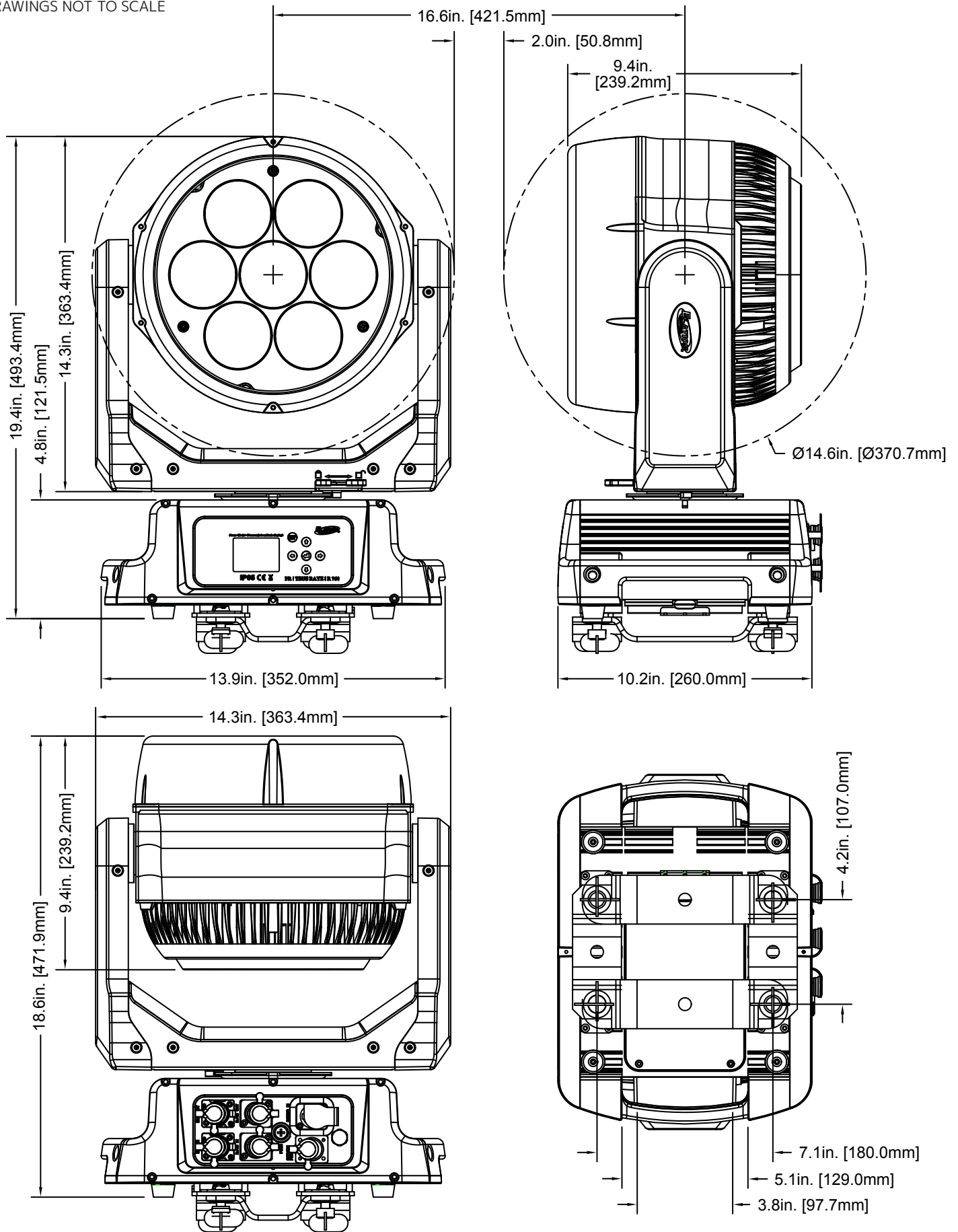

Specifications and documentation subject to change without notice.

OPTIONAL ACCESSORIES

ORDER CODE	ITEM
IP TESTER	IP Fixture Vacuum and Pressure Leak Tester
TRIGGER CAMP	Heavy Duty Wrap Around Hook Style Clamp
STR527	5 ft (1.5m) IP65 5-pin XLR Cable (additional cable lengths are available)

FCC STATEMENT

This device complies with Part 15 of the FCC Rules. Operation is subject to the following two conditions: (1) this device may not cause harmful interference, and (2) this device must accept any interference received, including interference that may cause undesired operation.

FCC RADIO FREQUENCY INTERFERENCE WARNINGS & INSTRUCTIONS

This product has been tested and found to comply with the limits as per Part 15 of the FCC Rules. These limits are designed to provide reasonable protection against harmful interference in a residential installation. This device uses and can radiate radio frequency energy and, if not installed and used in accordance with the included instructions, may cause harmful interference to radio communications. However, there is no guarantee that interference will not occur in a particular installation. If this device does cause harmful interference to radio or television reception, which can be determined by turning the device off and on, the user is encouraged to try to correct the interference by one or more of the following methods:

- Reorient or relocate the device.
- Increase the separation between the device and the receiver.
- Connect the device and the radio receiver to electrical outlets on two different circuits.
- Consult the dealer or an experienced radio/TV technician for help.



Europe Energy Saving Notice

Energy Saving Matters (EuP 2009/125/EC)

Saving electric energy is a key to help protecting the environment. Please turn off all electrical products when they are not in use. To avoid power consumption in idle mode, disconnect all electrical equipment from power when not in use. Thank you.

