



ARTISTETM
MONDRIAN
user manual

©2022 ELATION PROFESSIONAL all rights reserved. Information, specifications, diagrams, images, and instructions herein are subject to change without notice. ELATION PROFESSIONAL logo and identifying product names and numbers herein are trademarks of ELATION PROFESSIONAL. Copyright protection claimed includes all forms and matters of copyrightable materials and information now allowed by statutory or judicial law or hereinafter granted. Product names used in this document may be trademarks or registered trademarks of their respective companies and are hereby acknowledged. All non-ELATION brands and product names are trademarks or registered trademarks of their respective companies.

ELATION PROFESSIONAL and all affiliated companies hereby disclaim any and all liabilities for property, equipment, building, and electrical damages, injuries to any persons, and direct or indirect economic loss associated with the use or reliance of any information contained within this document, and/or as a result of the improper, unsafe, insufficient and negligent assembly, installation, rigging, and operation of this product.

Elation Professional USA | 6122 S. Eastern Ave. | Los Angeles, CA. 90040
323-582-3322 | 323-832-9142 fax | www.elationlighting.com | info@elationlighting.com

Elation Professional B.V. | Junostraat 2 | 6468 EW Kerkrade, The Netherlands
+31 45 546 85 66 | +31 45 546 85 96 fax | www.elationlighting.eu | info@elationlighting.eu

Elation Professional Mexico | AV Santa Ana 30 | Parque Industrial Lerma, Lerma, Mexico 52000
+52 (728) 282-7070

DOCUMENT VERSION



Due to additional product features and/or enhancements, an updated version of this document may be available online. Please scan the QR Code with your mobile device or visit www.elationlighting.com for the latest revision/update of this manual, before installation and/or programming.

Date	Document Version	Software Version \geq	DMX Channel Modes	Notes
05/26/20	1.0	1.2.1	42 / 68	Initial release.
06/19/20	1.1	1.2.1	42/68	Updated Thermal
03/04/21	1.2	1.2.3	NO CHANGE	Updated DMX traits, added Transportation & Handling Precaution
04/20/22	1.3	N/C	NO CHANGE	Updated General Information, added RDM
10/24/22	1.4	N/C	NO CHANGE	Updated Gobo Sizes
11/21/22	1.5	1.5.0	NO CHANGE	Updated System Menu, DMX Traits, Specifications

CONTENTS

General Information	4
Warranty Returns (USA Only)	5
Safety Guidelines	6
Fixture Transportation and Handling Maintenance Guidelines	8
Fixture Overview	9
Colors, Gobos, & Animation Wheel	10
SpectraColor Guide	11
Custom Gobos	12
GOBO Installation	13
Installation Guidelines	17
Remote Device Management (RDM)	20
System Menu	21
Fan Modes and Low Noise Operation	30
DMX Channel Functions and Values	31
Error Codes	43
Specifications	44
Dimensional Drawings	45
Optional Accessories FCC Statement	46

GENERAL INFORMATION

INTRODUCTION

Please read and understand the instructions in this manual carefully and thoroughly before attempting to operate this device. These instructions contain important safety and use information. ***This product is intended for use by professionally trained personnel only, and is not suitable for private use.***

UNPACKING

Every device has been thoroughly tested and has been shipped in perfect operating condition. Carefully check the shipping carton for damage that may have occurred during shipping. If the carton is damaged, carefully inspect the device for damage, and be sure all accessories necessary to install and operate the device have arrived intact. In the event damage has been found or parts are missing, please contact our customer support team for further instructions. Please do not return this device to your dealer without first contacting customer support. Please do not discard the shipping carton in the trash. Please recycle whenever possible.

BOX CONTENTS

Omega Brackets (x2)
Locking Power Cable

CUSTOMER SUPPORT

Contact **ELATION Service** for any product related service and support needs. Also visit forums.elationlighting.com with questions, comments or suggestions.

ELATION SERVICE USA - Monday - Friday 8:00am to 4:30pm PST
323-582-3322 | Fax 323-832-9142 | support@elationlighting.com

ELATION SERVICE EUROPE - Monday - Friday 08:30 to 17:00 CET
+31 45 546 85 63 | Fax +31 45 546 85 96 | support@elationlighting.eu

REPLACEMENT PARTS please visit parts.elationlighting.com



I M P O R T A N T N O T I C E !

**THERE ARE NO USER SERVICEABLE PARTS INSIDE THIS UNIT.
DO NOT ATTEMPT ANY REPAIRS YOURSELF; DOING SO WILL VOID YOUR MANUFACTURES WARRANTY. DAMAGES RESULTING FROM MODIFICATIONS TO THIS FIXTURE AND/OR THE DISREGARD OF SAFETY INSTRUCTIONS AND GUIDELINES IN THIS MANUAL VOID THE MANUFACTURES WARRANTY AND ARE NOT SUBJECT TO ANY WARRANTY CLAIMS AND/OR REPAIRS.**

LIMITED WARRANTY (USA ONLY)

- A. Elation Professional hereby warrants, to the original purchaser, Elation Professional products to be free of manufacturing defects in material and workmanship for a period of two years (730 days), and Elation Professional product rechargeable batteries to be free of manufacturing defects in material and workmanship for a period of six months (180 days), from the original date of purchase. This warranty excludes discharge lamps and all product accessories. This warranty shall be valid only if the product is purchased within the United States of America, including possessions and territories. It is the owner's responsibility to establish the date and place of purchase by acceptable evidence, at the time service is sought.
- B. For warranty service, send the product only to the Elation Professional factory. All shipping charges must be pre-paid. If the requested repairs or service (including parts replacement) are within the terms of this warranty, Elation Professional will pay return shipping charges only to a designated point within the United States. If any product is sent, it must be shipped in its original package and packaging material. No accessories should be shipped with the product. If any accessories are shipped with the product, Elation Professional shall have no liability what-so-ever for loss and/or or damage to any such accessories, nor for the safe return thereof.
- C. This warranty is void if the product serial number and/or labels are altered or removed; if the product is modified in any manner which Elation Professional concludes, after inspection, affects the reliability of the product; if the product has been repaired or serviced by anyone other than the Elation Professional factory unless prior written authorization was issued to purchaser by Elation Professional; if the product is damaged because not properly maintained as set forth in the product instructions, guidelines and/or user manual.
- D. This is not a service contract, and this warranty does not include any maintenance, cleaning or periodic check-up. During the periods as specified above, Elation Professional will replace defective parts at its expense, and will absorb all expenses for warranty service and repair labor by reason of defects in material or workmanship. The sole responsibility of Elation Professional under this warranty shall be limited to the repair of the product, or replacement thereof, including parts, at the sole discretion of Elation Professional. All products covered by this warranty were manufactured after January 1, 1990, and bare identifying marks to that effect.
- E. Elation Professional reserves the right to make changes in design and/or performance improvements upon its products without any obligation to include these changes in any products theretofore manufactured.
- F. No warranty, whether expressed or implied, is given or made with respect to any accessory supplied with the products described above. Except to the extent prohibited by applicable law, all implied warranties made by Elation Professional in connection with this product, including warranties of merchantability or fitness, are limited in duration to the warranty periods set forth above. And no warranties, whether expressed or implied, including warranties of merchantability or fitness, shall apply to this product after said periods have expired. The consumer's and/or dealer's sole remedy shall be such repair or replacement as is expressly provided above; and under no circumstances shall Elation Professional be liable for any loss and/or damage, direct and/or consequential, arising out of the use of, and/or the inability to use, this product.
- G. This warranty is the only written warranty applicable to Elation Professional products and supersedes all prior warranties and written descriptions of warranty terms and conditions heretofore published.

WARRANTY RETURNS

All returned service items whether under warranty or not, must be freight pre-paid and accompany a return authorization (R.A.) number. The R.A. number must be clearly written on the outside of the return package. A brief description of the problem as well as the R.A. number must also be written down on a piece of paper and included in the shipping container. If the unit is under warranty, you must provide a copy of your proof of purchase invoice. Items returned without a R.A. number clearly marked on the outside of the package will be refused and returned at customer's expense. You may obtain an R.A. number by contacting customer support.

SAFETY GUIDELINES

This fixture is a sophisticated piece of electronic equipment. To guarantee a smooth operation, it is important to follow all instructions and guidelines in this manual. Elation Professional is not responsible for injury and/or damages resulting from the misuse of this fixture due to the disregard of the information printed in this manual. Only qualified and/or certified personnel should perform installation of this fixture and only the original rigging parts (omega brackets) included with this fixture should be used for installation. Any modifications to the fixture and/or the included mounting hardware will void the original manufactures warranty and increase the risk of damage and/or personal injury.



PROTECTION CLASS 1 - FIXTURE MUST BE PROPERLY GROUNDED



**THERE ARE NO USER SERVICEABLE PARTS INSIDE THIS UNIT.
DO NOT ATTEMPT ANY REPAIRS YOURSELF; DOING SO WILL VOID YOUR MANUFACTURES WARRANTY. DAMAGES RESULTING FROM MODIFICATIONS TO THIS FIXTURE AND/OR THE DISREGARD OF SAFETY INSTRUCTIONS AND GUIDELINES IN THIS MANUAL VOID THE MANUFACTURES WARRANTY AND ARE NOT SUBJECT TO ANY WARRANTY CLAIMS AND/OR REPAIRS.**



**DO NOT PLUG FIXTURE INTO A DIMMER PACK!
NEVER OPEN THIS FIXTURE WHILE IN USE!
UNPLUG POWER BEFORE SERVICING FIXTURE!
NEVER TOUCH FIXTURE DURING OPERATION, AS IT MAY BE HOT!
KEEP FLAMMABLE MATERIALS AWAY FROM FIXTURE!**



**NEVER LOOK DIRECTLY INTO THE LIGHT SOURCE!
RETINA INJURY RISK - MAY INDUCE BLINDNESS!
SENSITIVE PERSONS MAY SUFFER AN EPILEPTIC SHOCK!**



**INDOOR / DRY LOCATIONS USE ONLY!
DO NOT EXPOSE FIXTURE TO RAIN AND MOISTURE!**



**MINIMUM DISTANCE TO OBJECTS/SURFACES
MUST BE 6.6 FEET (2 METERS)
MAXIMUM TEMP OF EXTERNAL SURFACE 185° F (85°C)
MINIMUM DISTANCE OF INFLAMMABLE MATERIALS
FROM THE SURFACE 1.6 FEET (0.5 METER)**

SAFETY GUIDELINES

 104.7 lbs. (47.5kg)	WARNING
	TWO PERSON LIFT REQUIRED

CAUTION

HIGH INTENSITY ULTRAVIOLET LIGHT



AVOID DIRECT EYE & SKIN EXPOSURE.
WEAR PROPER EYE & SKIN PROTECTION.
SEE MANUAL FOR SAFETY INSTRUCTIONS.

RISK GROUP 3 - RISK OF EXPOSURE TO ULTRAVIOLET UV RADIATION! FIXTURE EMITS HIGH INTENSITY WAVELENGTH OF ULTRAVIOLET UV LIGHT FROM THE UV COLOR FILTER. WEAR PROPER EYE AND SKIN PROTECTION. AVOID PROLONGED PERIODS OF EXPOSURE TO UV COLOR FILTER. AVOID WEARING WHITE COLOR CLOTHING AND/OR USING UV PAINTS ON SKIN. AVOID DIRECT EYE AND/OR SKIN EXPOSURE AT DISTANCES LESS THAN 11 feet (3.3m). DO NOT OPERATE FIXTURE WITH DAMAGED/MISSING EXTERNAL COVERS. DO NOT LOOK DIRECTLY INTO THE UV LIGHT AND/OR VIEW UV

LIGHT DIRECTLY WITH OPTICAL INSTRUMENTS THAT MAY CONCENTRATE THE LIGHT/RADIATION OUTPUT. INDIVIDUALS SUFFERING FROM A RANGE OF EYE CONDITIONS, SUNLIGHT EXPOSURE DIS-ORDERS, OR INDIVIDUALS USING PHOTSENSITIVE MEDICATION, MAY RECEIVE DISCOMFORT IF EXPOSED TO THE ULTRAVIOLET UV LIGHT EMITTED FROM THE UV LED.

DO NOT TOUCH the fixture housing during operation. Turn OFF the power and allow approximately 15 minutes for the fixture to cool down before serving.

DO NOT shake fixture, avoid brute force when installing and/or operating fixture.

DO NOT operate fixture if the power cord is frayed, crimped, damaged and/or if any of the power cord connectors are damaged and do not insert into the fixture securely with ease. **NEVER** force a power cord connector into the fixture. If the power cord or any of its connectors are damaged, replace it immediately with a new one of similar power rating.

DO NOT block any air ventilation slots.

All fan and air inlets must remain clean and never blocked.

Allow approx. 6" (15cm) between fixture and other devices or a wall for proper cooling.

When installing fixture in a suspended environment, always use mounting hardware that is no less than M10 x 25 mm, and always install fixture with an appropriately rated safety cable.

Always disconnect fixture from main power source before performing any type of service and/or cleaning procedure. Only handle the power cord by the plug end, never pull out the plug by tugging the wire portion of the cord.

During the initial operation of this fixture, a light smoke or smell may emit from the interior of the fixture. This is a normal process and is caused by excess paint in the interior of the casing burning off from the heat associated with the lamp and will decrease gradually over time.

Consistent operational breaks will ensure fixture will function properly for many years.

FIXTURE TRANSPORT AND HANDLING

The device is a large format fixture that contains delicate optics and glass filters. While this product was carefully designed to be roadworthy, it must be handled carefully during transportation. Before transport, ensure that the color flags inside the unit are placed in an OPEN position. For superior impact protection, the fixture is shipped in a custom fitted high-density Foam Inlay (FIL). This FIL must be used inside the road-cases for transportation.

DO NOT Tip the case over, and avoid all shocks and rough handling, especially “tipping”, the practice of tipping the fixture-case over to its side and onto a hard surface. The case must ride on its wheels so that the fixture-head remains horizontal during transportation.

MAINTENANCE GUIDELINES



DISCONNECT POWER BEFORE PERFORMING ANY MAINTENANCE!

CLEANING

Frequent cleaning is recommended to insure proper function, optimized light output, and an extended life. The frequency of cleaning depends on the environment in which the fixture operates: damp, smoky or particularly dirty environments can cause greater accumulation of dirt on the fixture’s optics. Clean the external lens surface at least every 20 days with a soft cloth to avoid dirt/debris accumulation. **NEVER** use alcohol, solvents, or ammonia-based cleaners.

MAINTENANCE

Regular inspections are recommended to insure proper function and extended life. There are no user serviceable parts inside this fixture, please refer all other service issues to an authorized Elation service technician. Should you need any spare parts, please order genuine parts from your local Elation dealer. Please refer to the following points during routine inspections:

- A detailed electric check by an approved electrical engineer every three months, to make sure the circuit contacts are in good condition and prevent overheating.
- Be sure all screws and fasteners are securely tightened at all times. Loose screws may fall out during normal operation resulting in damage or injury as larger parts could fall. Check for any deformations on the housing, color lenses, rigging hardware and rigging points (ceiling, suspension, trussing). Deformations in the housing could allow for dust to enter into the fixture. Damaged rigging points or unsecured rigging could cause the fixture to fall and seriously injure a person(s).
- Electric power supply cables must not show any damage, material fatigue or sediments. **NEVER** remove the ground prong from the power cable.

FIXTURE OVERVIEW

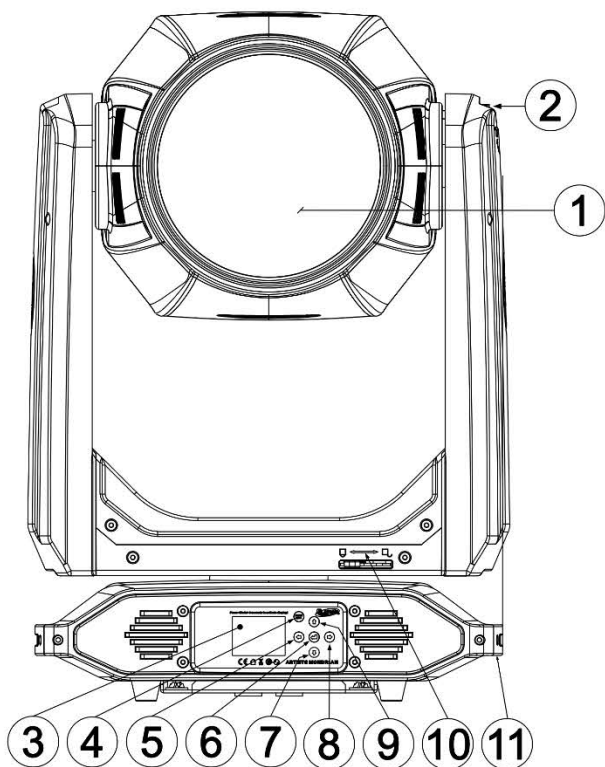

1. Lens
2. Tilt Lock
3. System Menu Display
4. MODE/ESC Button
5. LEFT Button
6. ENTER Button
7. DOWN Button
8. RIGHT Button
9. UP Button
10. PAN Lock
11. Carrying Handle(s)

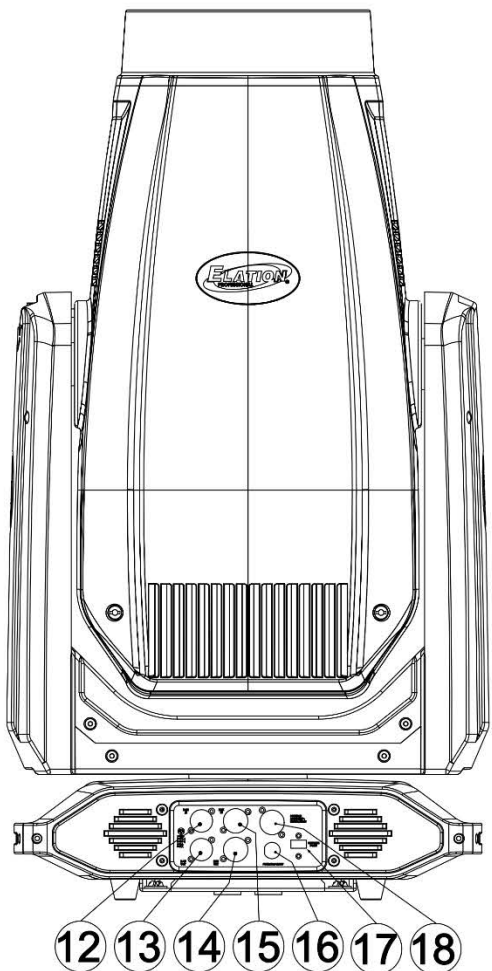

12. RJ45 Input
13. RJ45 Output
14. 5pin DMX Input
15. 5pin DMX Output
16. Fuse
17. Service Port
18. IP65 Locking Power Input

COLORS, GOBOS, & ANIMATION WHEEL

COLOR FLAGS

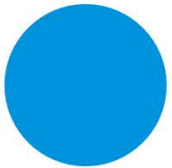

CYAN



MAGENTA



YELLOW

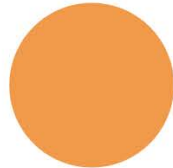

C.T.O.

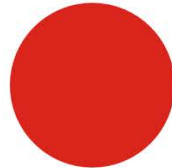

RED

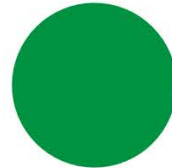

GREEN

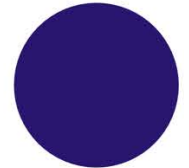

BLUE

COLOR WHEEL

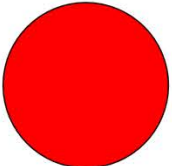

RED

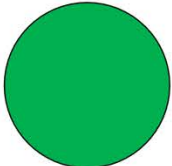

GREEN



UV

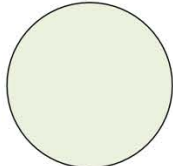

HCRI

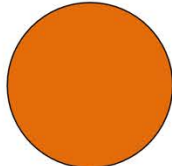

AMBER

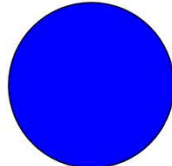

BLUE

ROTATING GOBO WHEEL 1

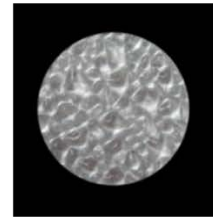
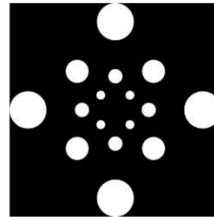
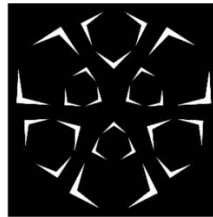
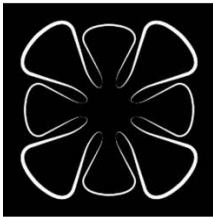

FIXED GOBO WHEEL 2

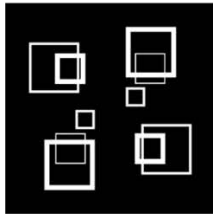
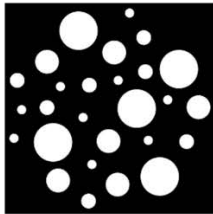

ANIMATION WHEEL

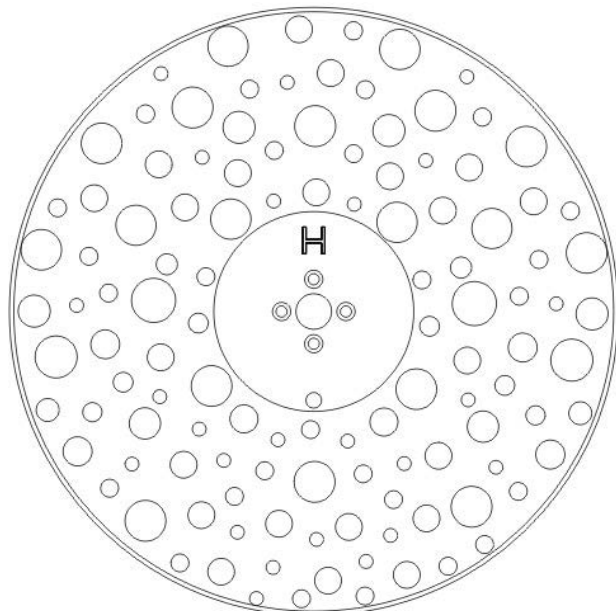

SPECTRACOLOR GUIDE

The Mondrian's innovative SpectraColor system combines the established and well known CMY / CTO controls with three Pure RGB flags that are seamlessly adjustable. These flags greatly enhance the possible color range of the Mondrian for some truly outstanding colors that can be difficult to achieve with only CMY controls.

It is recommended to familiarize yourself with this unique color system, to fully unlock the creative potential of the SpectraColor array.

Cyan, Magenta, and Yellow saturation chosen for a wide color range and are aligned with other colors in the Artiste range. CMY is a subtractive color mix which removes certain colors from the light to create the desired color. Flags can be combined in any saturation to create a wide range of mixed colors.

RGB are "pure" color points chosen for best saturation. These are also subtractive, e.g. adding the Red flag will remove all other wavelengths. While it is possible to overlap the RGB colors it will eventually black out the fixture as all colors are essentially reducing towards no output.

On consoles they should be shown as Pure Red, Pure Green and Pure Blue. This is done so console colors pickers do not interact with the RGB flags. All color flags must default to 0% in the console profiles.

Mixing CMY colors is identical to many other fixtures in the market. CMY colors can of course combine with the CTO to create a warmer array of colors. Overall, the behavior of the CMY system should feel familiar, and with the high intensity of the Mondrian, all colors are brilliant and powerful.

The CTO filter is designed to adjust the Mondrian from its native color temperature of 6500K to 2700K. Full CTO in combination with Cyan Magenta or Yellow allow for a warmer color palette. For example, yellow shifts from a slightly greenish tone to a warm amber yellow. Utilizing the adjustable CTO with the CMY system greatly enhances the color range of the Mondrian.

Using Pure Colors

Pure Red, Green or Blue are ideal colors to create subtle hues to saturated colors. Mixing a slight blue shifts the Mondrian from White over CTB over light to medium purples until it reaches a rich Medium Blue. Using Green allows teals and green tints similar to fluorescent fixtures until it transitions into a bright medium green. These color tones makes the Mondrian an ideal tool for theater and opera designers as the SpectraColor system allows to replicate many color spectrums associated with unique light sources like metal halide, sodium vapor or fluorescent tubes out of one fixture.

Creating Color Mixes Using SpectraColor

CMY and RGB flags can be combined as well to widen the color gamut of the CMY mix. Start with a slight to saturated CMY color, then add a little of Red, Green, or Blue to change the hue. Never use RGB together, only one of those colors at a time will be useful. Otherwise, the fixture will only get darker as overlapping RGB acts like a dim to black.

Perceived Color Brightness

Please be aware that due to the very high intensity of the Mondrian the CMY colors may not look fully saturated, especially when placed next to a lower intensity fixture. This is misleading as your eye cannot handle the high intensity well and colors that are in fact identical may appear different to your eye. To confirm simply dim down the Mondrian to match the output level of a comparison fixture. You should find color appearing more saturated, even though nothing has changed on the color itself. Reducing the output helps your eye to see the color better.

CUSTOM GOBOS

ROTATING GOBO WHEEL 1		
Position	1 - 5	6
Gobo O.D. (Max. Outer Diameter)	φ33.8mm	
Gobo I.D. (Mx. Image Diameter)	φ24mm	
Gobo Holder Diameter	φ34mm	φ34mm
Gobo Thickness	1.1mm±0.1mm	1.1mm±0.1mm
Gobo Material	Glass Substrate: Schott Borofloat 33 (or other comparable borosilicate glass) Maximum Operating Temperature: 450°C Recommended coating: 1st Forward Black Chrome 2nd Reflective with Dichroic Mirror	

FIXED GOBO WHEEL 2	
Position	1 - 6
Gobo O.D. (Max. Outer Diameter)	φ33.8mm
Gobo I.D. (Mx. Image Diameter)	φ24mm
Gobo Holder Diameter	φ34mm
Gobo Thickness	1.1mm±0.1mm
Gobo Material	Glass Substrate: Schott Borofloat 33 (or other comparable borosilicate glass) Maximum Operating Temperature: 450°C Recommended coating: 1st Forward Black Chrome 2nd Reflective with Dichroic Mirror

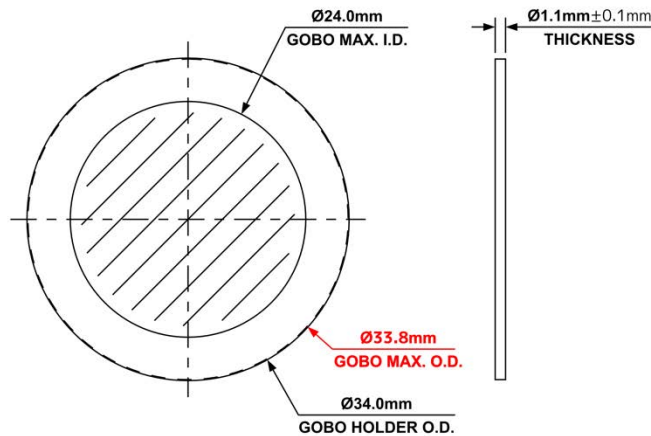

IMPORTANT NOTICE REGARDING CUSTOM GOBOS

Due to the high temperature optical system, special material as listed above is required for custom gobos. Due to varying manufacturing processes and tolerances, it is highly recommended to provide a gobo sample and holder from the fixture to the custom gobo vendor for accurate sizing. Extended testing of custom gobo designs is highly recommended prior to use. Contact ELATION SERVICE for further information.

ELATION SERVICE USA - Monday - Friday 8:00am to 4:30pm PST
 323-582-3322 | Fax 323-832-9142 | support@elationlighting.com

ELATION SERVICE EUROPE - Monday - Friday 08:30 to 17:00 CET
 +31 45 546 85 63 | Fax +31 45 546 85 96 | support@elationlighting.eu

GOBO INSTALLATION



1. Before removing either cover, place fixture on a stable flat surface in an **INDOOR DUST FREE** location. Ensure moving head is locked into a neutral upright position with both PAN and TILT locks engaged. If necessary, the fixture can be locked at various angles as seen below.



2. Loosen (2x) $\frac{1}{4}$ -turn Phillips-head screws on cover. (screws integrated into covers - cannot be removed) Gently lift covers and unclip safety cable to remove completely from the fixture.

It may be necessary to remove both covers to locate the GOBO Wheel module.

GOBO INSTALLATION

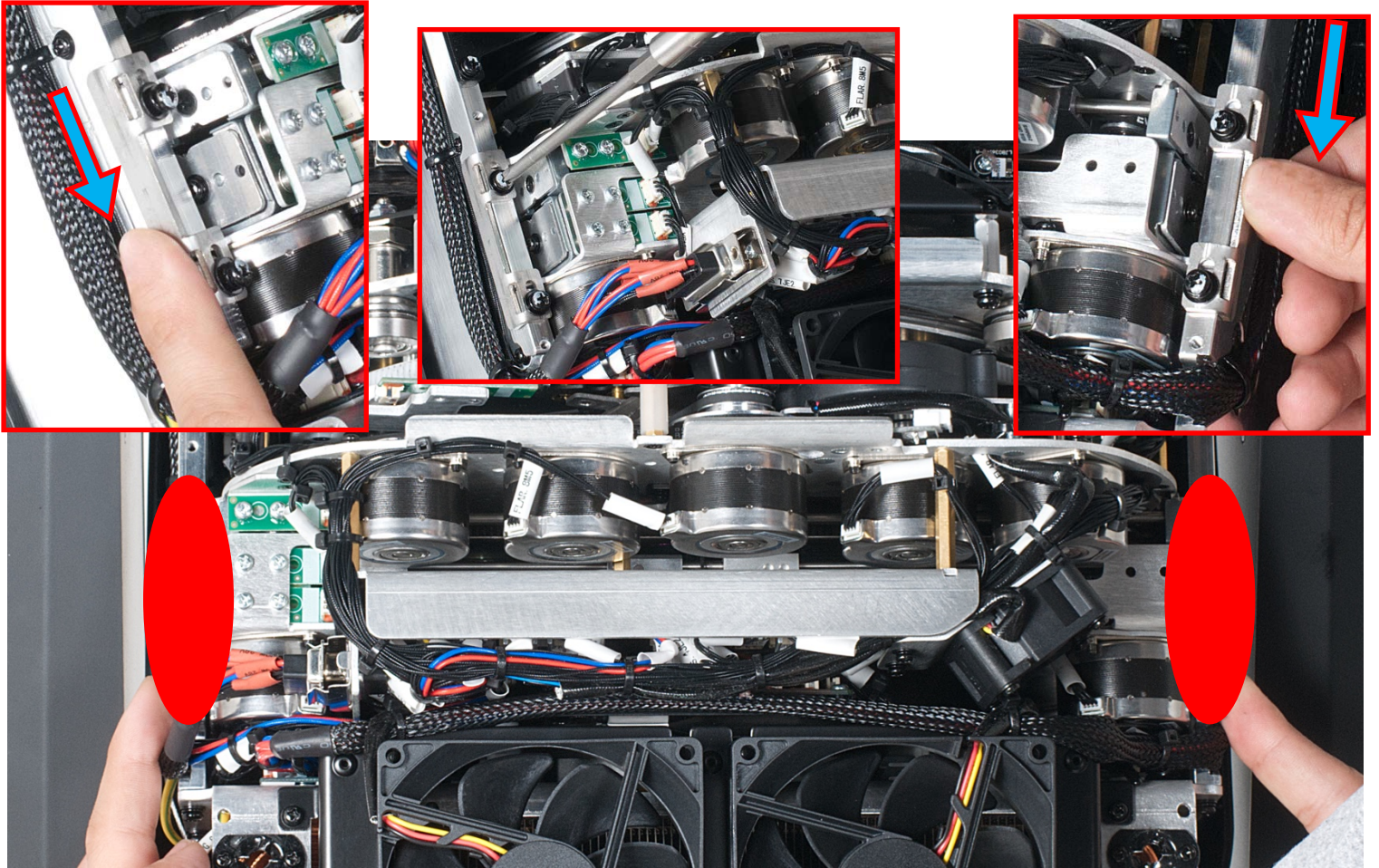

3. The GOBO Wheel module is secured to the fixture frame rail with (2x) sliding slotted brackets. To remove the module, loosen the (4x) Philips-head screws just enough (do not remove them) to allow the slotted brackets to slide down.

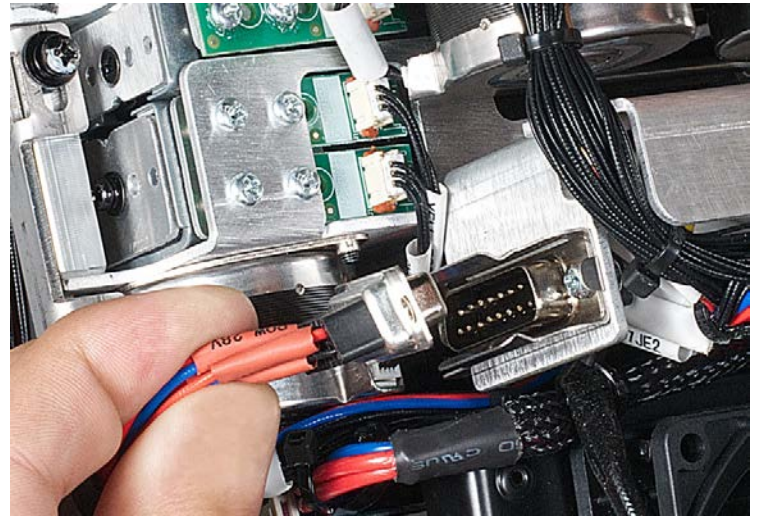
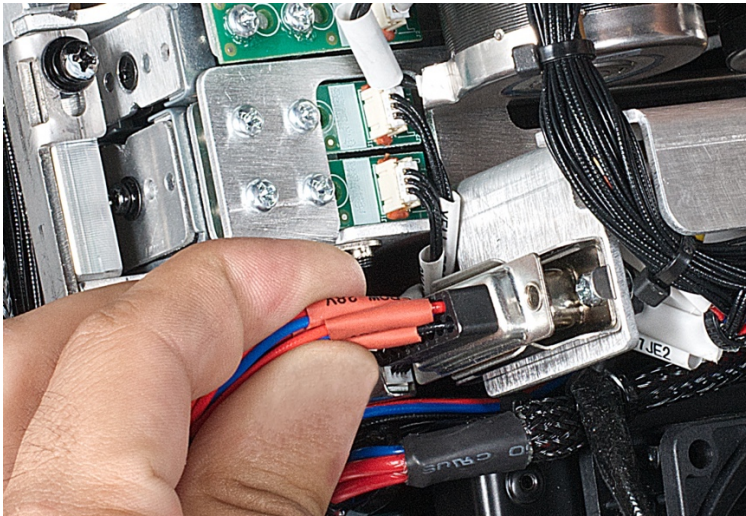

4. Locate the 15-pin connector and carefully unplug it from its socket. **DO NOT USE FORCE TO REMOVE!** (Note: do not pull the connector out by its wires. The finger placement in the above photos was used strictly to illustrate the connector location before and after).

GOBO INSTALLATION

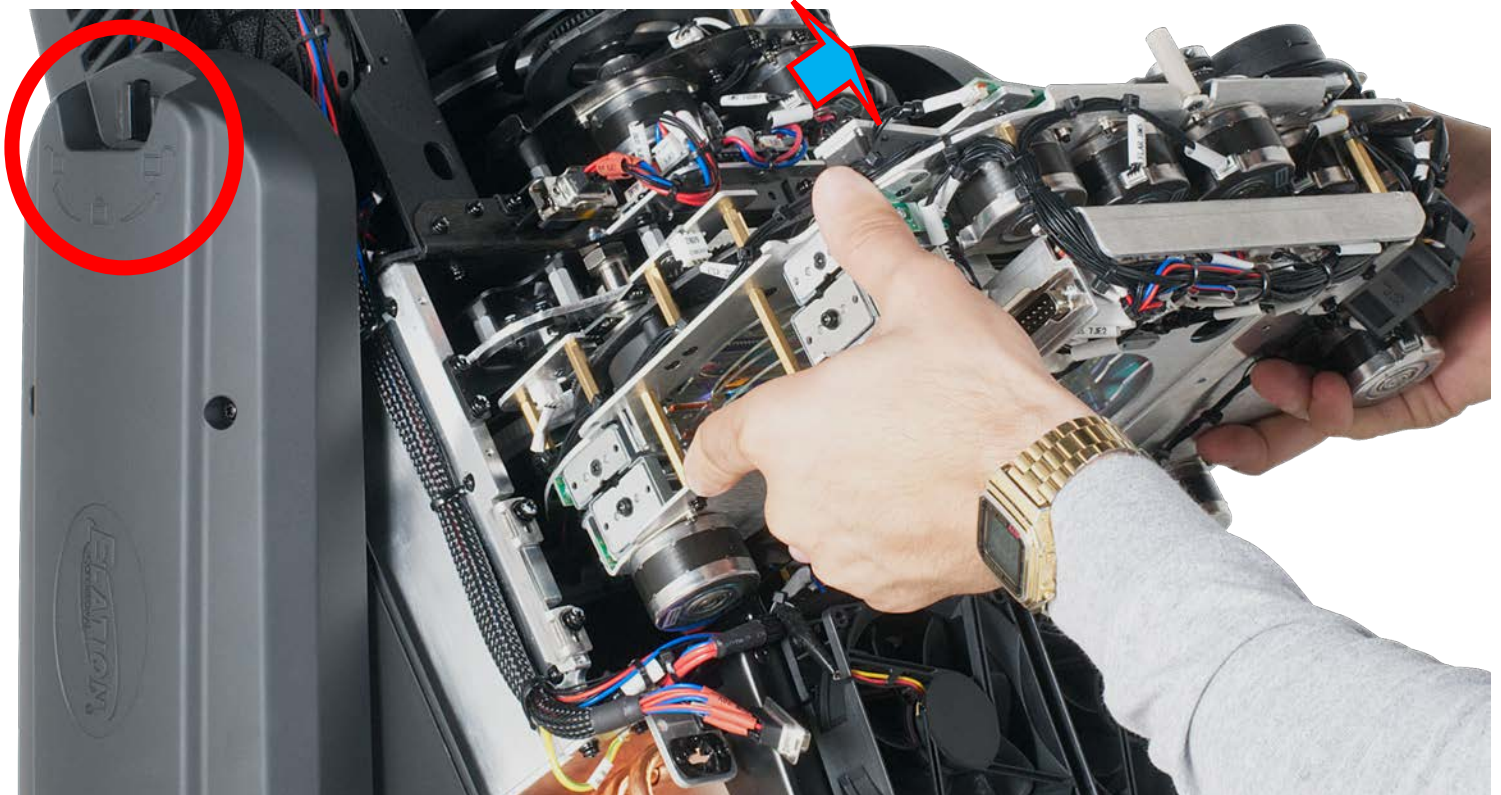

5. With the moving head locked in a convenient position (note vertical locked position), slide the GOBO Wheel module completely out and away from the fixture.



6. Carefully place the module on a stable flat surface in an **INDOOR DUST FREE** location.

GOBO INSTALLATION



7. REPLACING A ROTATING GOBO

Locate the specific Rotating GOBO to be replaced. Carefully grip the GOBO and gently lift it slightly up to pull it out and away until it fully clears the GOBO Wheel.



8. Locate the tab of the retaining spring, then using a precision pick (or similar tool), carefully press the retaining spring inward to relieve the tension. Remove the retaining spring and carefully separate the GOBO from the GOBO Holder. Lastly, remove the flat washer attached to the removed GOBO and attach it to the desired replacement GOBO. Install the replacement Rotating GOBO following the steps above in reverse order.



CAUTION: TAKE CARE NOT TO SCRATCH GOBO OR GOBO HOLDER!

INSTALLATION GUIDELINES



FLAMMABLE MATERIAL WARNING

Keep fixture minimum 5.0 feet (1.5m) away from flammable materials and/or pyrotechnics.



ELECTRICAL CONNECTIONS

A qualified electrician should be used for all electrical connections and/or installations.



USE CAUTION WHEN POWER LINKING OTHER MODEL FIXTURES AS THE POWER CONSUMPTION OF OTHER MODEL FIXTURES MAY EXCEED THE MAX POWER OUTPUT ON THIS FIXTURE. CHECK SILK SCREEN FOR AMX AMPS.



**MINIMUM DISTANCE TO OBJECTS/SURFACES
MUST BE 6.6 FEET (2 METERS)**



**MINIMUM DISTANCE OF INFLAMMABLE MATERIALS
FROM THE SURFACE 1.6 FEET (0.5 METER)**



MAXIMUM TEMPERATURE OF EXTERNAL SURFACE 185° F (85°C)



DO NOT INSTALL THE FIXTURE IF YOU ARE NOT QUALIFIED!

Fixture **MUST** be installed following all local, national, and country commercial electrical and construction codes and regulations.

Before rigging/mounting a single fixture or multiple fixtures to any metal truss/structure or placing the fixture(s) on any surface, a professional equipment installer **MUST** be consulted to determine if the metal truss/structure or surface is properly certified to safely hold the combined weight of the fixture(s), clamps, cables, and accessories.

Fixture ambient operating temperature range is **14° to 113°F. (-10° to 45°C)**.

Do not use the fixture under or above this temperature.

Fixture(s) should be installed in areas outside walking paths, seating areas, or away from areas where unauthorized personnel might reach the fixture by hand.

NEVER stand directly below the fixture(s) when rigging, removing or servicing.

Overhead fixture installation must always be secured with a secondary safety attachment, such as an appropriately rated safety cable.

Allow approximately 15 minutes for the fixture to cool down before servicing.

RIGGING

Overhead rigging requires extensive experience, including amongst others calculating working load limits, installation material being used, and periodic safety inspection of all installation material and the fixture. If you lack these qualifications, do not attempt the installation yourself. Improper installation can result in bodily injury.



ALWAYS ATTACH AN APPROPRIATELY RATED SAFETY CABLE (NOT INCLUDED) THAT MEETS ALL LOCAL, NATIONAL, AND COUNTRY CODES AND REGULATIONS WHENEVER INSTALLING FIXTURE IN A SUSPENDED ENVIRONMENT!

INSTALLATION GUIDELINES

OMEGA BRACKETS INSTALLATION

Insert the Omega Brackets into the matching holes on the bottom of the fixture. Secure the Omega Brackets to the fixture by turning each quick-lock fastener ¼ turn clockwise; making sure the fastener is completely locked. Omega Brackets can be installed into the fixture base as illustrated below.

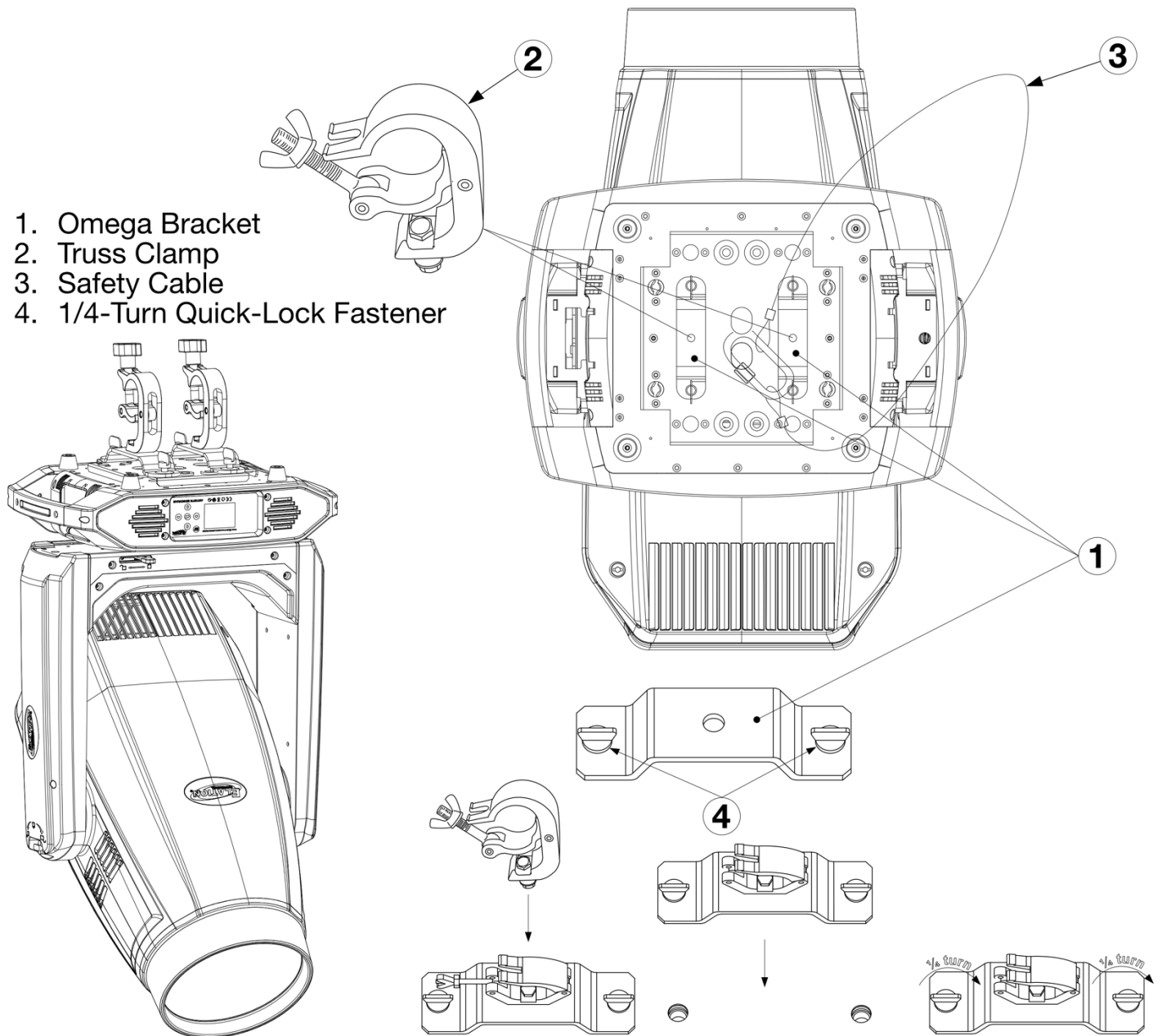

CLAMP INSTALLATION

When mounting fixture to truss, be sure to secure an appropriately rated professional grade rigging clamp to the included **Omega Brackets** using an M10 screw fitted through the center hole of the **Omega Brackets**. The fixture provides a built-in rigging point for a **SAFETY CABLE** (not included). Be sure to only use one of the designated rigging points for the safety cable and never secure a safety cable to a carrying handle.

INSTALLATION GUIDELINES

ART-NET | sACN CONNECTION

When connecting fixture to a network switch to control multiple devices, a **Gigabit Ethernet Switch** that supports **IGMP (Internet Group Management Protocol)** is required. Using a **Gigabit Ethernet Switch** that does not support **IGMP** can cause erratic behavior of all connected devices to the switch. Click link below for more information about IGMP.

https://en.wikipedia.org/wiki/Internet_Group_Management_Protocol

POTENTIAL INTERNAL FIXTURE DAMAGE FROM EXTERNAL SOURCES OF LIGHT BEAMS

External sources of light beams from direct sunlight, lighting moving head fixtures, and lasers, which are focused directly on the exterior housing and/or penetrate the front lens opening of ELATION lighting fixtures, can cause severe internal damage including burning to optics, dichroic color filters, glass and metal gobos, prisms, animation wheels, frost filters, iris, shutters, motors, belts, wiring, discharge lamps, and LEDs.

This issue is not specific only to ELATION lighting fixtures, it is a common issue with lighting fixtures from all manufacturers. Although there is no true way to fully prevent this issue from happening, the guidelines below can prevent any potential damage from occurring if followed. Contact ELATION Service for more details.

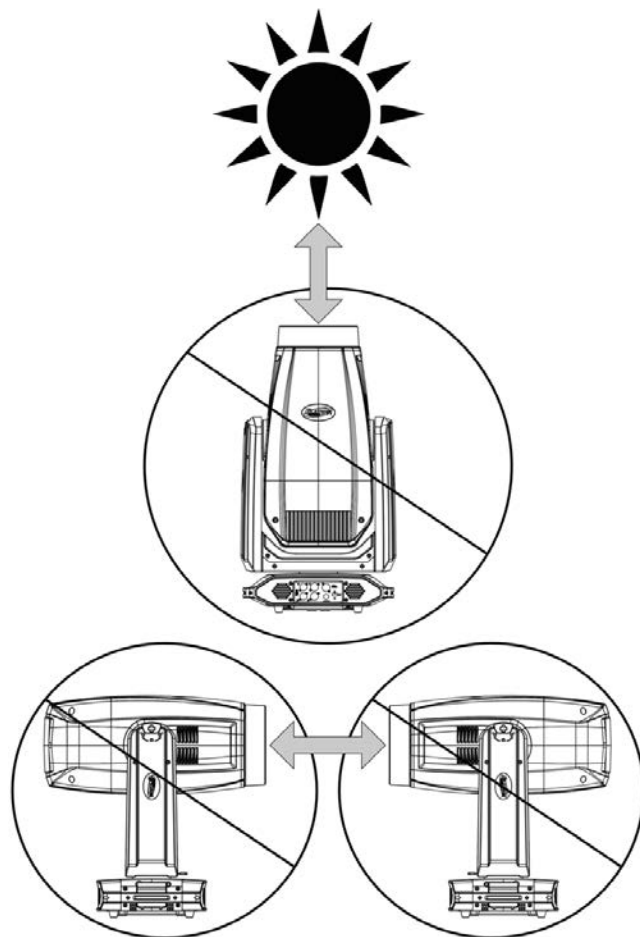

DO NOT EXPOSE THE FIXTURE AND/OR FRONT LENS OPENING TO LIGHT BEAMS FROM DIRECT SUNLIGHT, OTHER LIGHTING MOVING HEAD FIXTURES, AND LASERS WHILE UNPACKING, INSTALLATION, USE, AND EXTENDED IDLE TIMES OUTDOORS. DO NOT FOCUS A LIGHT BEAM FROM ONE LIGHTING FIXTURE DIRECTLY TOWARDS ANOTHER.

SUN PROTECTION MODE/HIBERNATION MODE

This state can be set via DMX, or it will go into this state after 3 minutes without a DMX signal.

When the sun protection is activated, the pan-and-tilt function of the moving-head will position the lens away from direct sunlight, or other high intensity light source, to protect the internal belts, electronics etc. from burn damage.

When the unit is in the 'sun protection state', it uses its accelerometer sensors (X-Y-Z) (only present on discharge units and IP units) to position the front lens downwards, even when the unit(s) will be moved from its position. This will keep on changing the position of the head.

Note that 'manual mode' overrides the 'sun-protection mode'.

The hibernation function is an incredibly old feature that puts the unit into a 'sleep state' to save power (this is a state whereas only the electronics remain on, and all other functions are turned off, functions such as motors lamps etc.). This state is automatically activated when no DMX signal is present for the set time (1-99min or off).

INSTALLATION GUIDELINES

RIGGING

Overhead rigging requires extensive experience, including among others, calculating load limits, installation material being used, and periodic safety inspection of all installation material and the fixture. If you lack these qualifications, do not attempt the installation yourself. Improper installation can result in bodily injury. The Artiste Mondrian CANNOT be mounted sideways, up and down only.

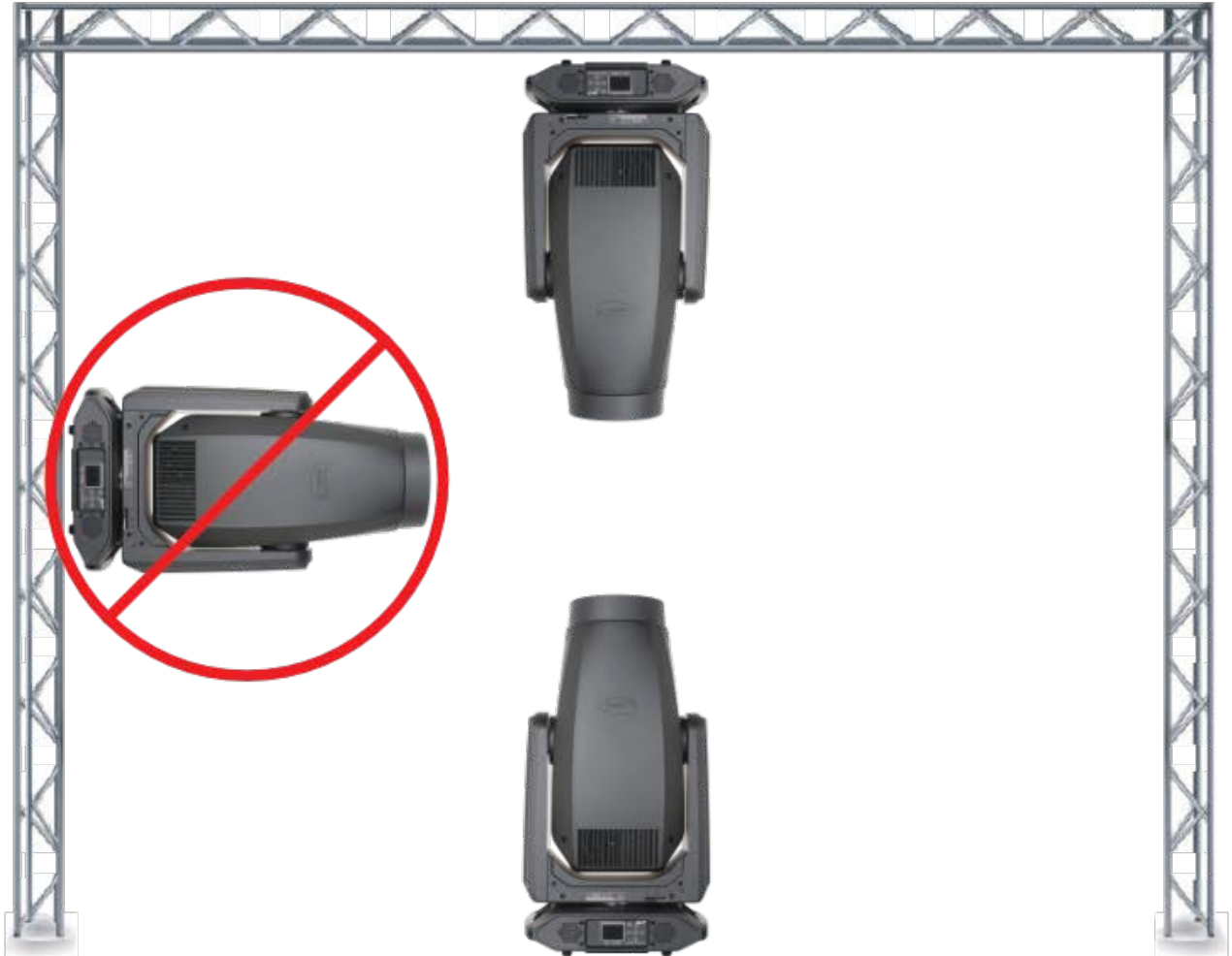

REMOTE DEVICE MANAGEMENT (RDM)

NOTE: For RDM to work properly, RDM enabled equipment must be used throughout the entire system, including DMX data splitters and wireless systems.

Remote Device Management (RDM) is a protocol that sits on top of the DMX512 data standard for lighting, allowing the DMX systems of the fixtures to be modified and monitored remotely. This protocol is ideal for instances in which a unit is installed in a location that is not easily accessible.

With RDM, the DMX512 system becomes bi-directional, allowing a compatible RDM enabled controller to send out a signal to devices on the wire, as well as allowing the fixture to respond (known as a *GET* command). The controller can then use its *SET* command to modify settings that would typically have to be changed or viewed directly via the unit's display screen, such as the DMX Address, DMX Channel Mode, and Temperature Sensors.

FIXTURE RDM INFORMATION:

RDM Code	Device ID	Device Model ID	Personality ID
0X60D	OPEN	1549	OPEN

Please be aware that not all RDM devices support all RDM features, and therefore it is important to check beforehand to ensure that the equipment that you are considering includes all of the features that you require.

The following parameters are accessible in RDM on this device:

Sensor Definition
Sensor Value
Device Model Description
Manufacturer Label
Device Label
DMX Personality
DMX Personality Description
Device Hours
Pan Invert
Tilt Invert
Display Invert

SYSTEM MENU

The fixture includes an easy to navigate system menu. The control panel (see image below) located on the front of the fixture, provides access to the main system menu and is where all necessary system adjustments are made to the fixture. During normal operation, pressing **MODE/ESC** button once will access the fixture's main menu. Once in the main menu you can navigate through the different functions and access the sub-menus with the **UP**, **DOWN**, **RIGHT**, and **LEFT** buttons. Once you reach a field that requires adjusting, press the **ENTER** button to activate that field and use the **UP** and **DOWN** buttons to adjust the field. Pressing the **ENTER** button once more will confirm your setting. You may exit the main menu at any time without making any adjustments by pressing the **MODE/ESC** button.

To access the LCD Menu Control Display via the internal battery, press and hold the **MODE/ESC** button for 3 seconds. The LCD Menu Control Display will shut **OFF** automatically about 1 minute from the last button press.

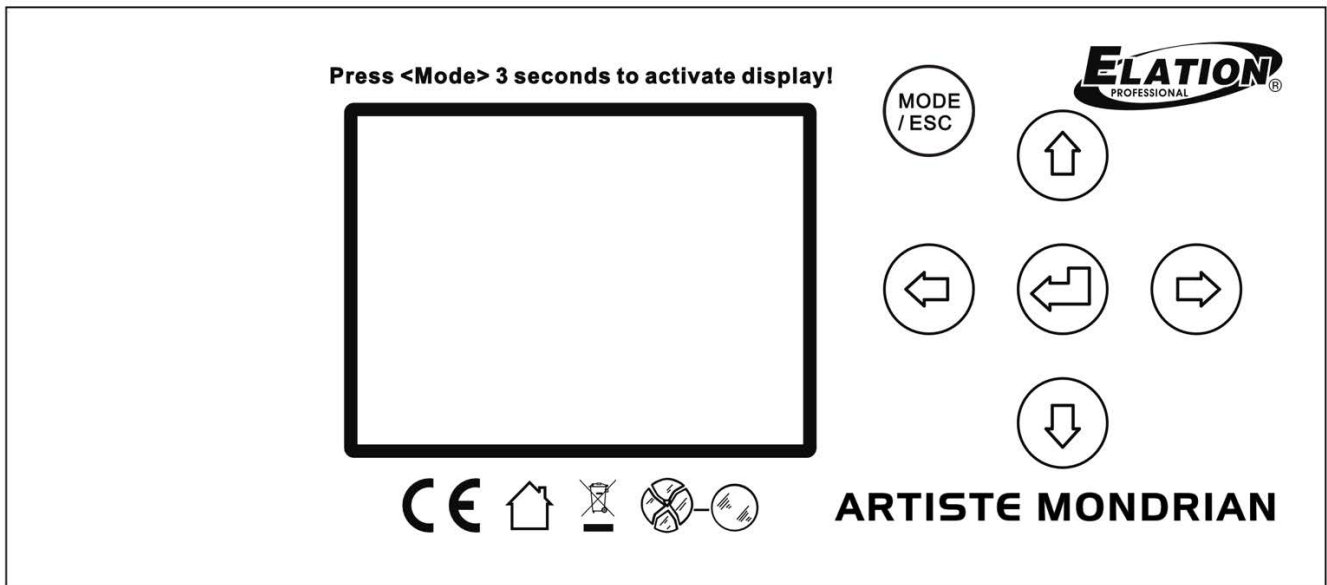

ELATION ARTISTE MONDRIAN™ S Y S T E M M E N U

Supports Software Versions: ≥ 1.5.0

Features subject to change without notice.

*Rotation direction (Clockwise/Counterclockwise) and control of effects depends on head orientation and Pan/Tilt settings.

MAIN MENU	SUB MENU	OPTIONS / VALUES (Default Settings in BOLD)	DESCRIPTION
FUNCTION	Set Dmx Address	A001~Axxx	DMX Address Setting
	Dmx Value	ALL, *Function/Effect = XXX (Control, Pan, Pan Fine, ...)	DMX Value Display
	Secondary Mode	Secondary1, Secondary2, Secondary3	Secondary Setting
	Auto Program	Primary / Alone	Auto Program
INFORMATION	Time Information	Current Time	XXXX (Hours) Fixture Run Time From Power ON
		Total Run Time	XXXX (Hours) Fixture Total Run Time
		Last Run Time	XXXX (Hours) Fixture Last Run Time
		LastRun Password	Password= 038 (PSWD Required)
		Clear Last Run	ON / OFF Clear Fixture Last Run Time
	Temperature Info	LED Temperature	XXX C° / F° Temperature of LED
		Base Temperature	XXX C° / F° Temperature in Fixture Base
		Head Temperature	XXX C° / F° Temperature in Fixture Head
	Ethernet IP	000.000.000.000 000.000.000.000	Displays Fixture Ethernet Address
	Fan Info	HeadFan: xxxx RPM, ...	Displays Fan Info
Software Version	Vx.x.x	Software Version	
Error Info	Error Record 1 ~ Error Record 10	Fixture Last 10 Error Codes	
PERSONALITY	Status Settings	Address via DMX	ON/OFF Address Via DMX
		No DMX Status	Close / Hold / Auto Fixture State When NO DMX Signal
		Pan Reverse	ON/OFF Pan Reverse Movement
		Tilt Reverse	ON/OFF Tilt Reverse Movement
		Pan Degree	630/ 540 Pan Degree Select
		Feedback	ON/OFF Movement Feedback
		Movement Speed	Normal / Slow Movement Speed
		CMY Speed	Normal / Fast
		P/T Brake Mode	Smooth /Fast Pan/Tilt Brake Mode
		Hibernation	OFF, 01M~99M, 15M Stand By Mode
	Service Setting	Password	Password= 050 Service Password
		Clear Err. Info	ON/OFF Clear Error Info (PSWD Required); Password "11", enable FollowSpot function; use password "60" to open wireless related menu
		USB Update	YES/ NO Service Port - Software Updates
	Fans Control	Auto , High, Low, Studio, Mute	Select Fan Speeds
	Display Setting	Shutoff Time	02~60m 05m Display Shut Off Time
		Display Reverse	ON/OFF Display Reverse 180°
		Key Lock	ON/OFF Key Lock
	Temperature C/F	Celsius/ Fahren	Temperature Switch Between C° / F°
	Initial Status	*Function/Effect = XXX... (Control, Pan, Pan Fine, ...)	Initial Effect Position
	Select Signal	DMX Only	DMX In/Out
		Art-Net	Select Art-Net
		sACN	Activate sACN
	Ethernet IP	XXX.XXX.XXX.XXX	Ethernet IP (PSWD Required)
	Ether Mask IP	XXX.XXX.XXX.XXX	Ethernet Mask IP (PSWD Required)
	Set Universe	000 - 32767	Set ArtNet Universe
	DHCP	On / Off	Auto assign IP address
	Dimmer Mode	Standard , Stage, TV, Architectural, Theatre, Stage2, Delay 0s, 0.1s, 0.2s... 10s	Set Dimmer Mode
	Refresh	1200 , 900-1500, 2500, 4000, 5000, 6000, 10000, 15000, 20000, 25000 (Hz)	Set LED Refresh Rate
	DimmerCurve	Linear , Square, InverseSquare, S-Curve	Set Dimmer Curve Mode
	Reset Default	ON/OFF	Passcode= 011 Restore Factory Settings (PSWD Required)

*Function/Effect: All, Control, Pan, Pan Fine, Tilt, Tilt Fine, Cyan, Cyan Fine, Magenta, Magenta Fine, Yellow, Yellow Fine, CTO, CTO Fine, Red, Red Fine, Green, Green Fine, Blue, Blue Fine, Color1 Wheel, Color1 Fine, Gobo1, Gobo1_Rot, Gobo1_Rot_F, Gobo2, Gobo2_Rot, Gobo2_Rot_F, Prism, Prism_Rot, Prism_Rot_F, Focus, Focus Fine, Zoom, Zoom Fine, Auto Focus, Auto Focus_F, Strobe, Dimmer, Dimmer Fine, Dimmer Mode, Iris, Iris Fine, Frost, Animation, AnimationRot, CMY Speed, CMY Macro, Blade1A, Blade1A Fine, Blade1B, Blade1B Fine, Blade2A, Blade2A Fine, Blade2B, Blade2B Fine, Blade3A, Blade3A Fine, Blade3B, Blade3B Fine, Blade4A, Blade4A Fine, Blade4B, Blade4B Fine, AllBlade_Rot, AllBlade_Rot_F, AllBladeSpeed, AllBladeMacro, Move Speed

ELATION ARTISTE MONDRIAN™ S Y S T E M M E N U

Supports Software Versions: ≥ 1.5.0

Features subject to change without notice.

*Rotation direction (Clockwise/Counterclockwise) and control of effects depends on head orientation and Pan/Tilt settings.

MAIN MENU	SUB MENU	OPTIONS / VALUES (Default Settings in BOLD)	DESCRIPTION	
Reset Function	Reset All		Reset All Motors	
	Reset Pan&Tilt		Reset Pan/Tilt	
	Reset Colors		Reset Colors	
	Reset Gobos		Reset Gobos	
	ResetZoomModules		Zoom	
	Reset Others		Reset Other Motors	
Effect Adjust	Test Channel	*Function/Effect (Control, Pan,...)	Test function	
	Manual Control	*Function/Effect (Control, Pan,...)	Fine Adjustments	
	Calibration	Calibration Password Pan=xxx, ...	Password 050 (PSWD Required)	
User Mode Set	User Mode	Standard Mode	DMX Channel Modes	
		Extended Mode		
Edit Program	Select Program	Auto Pro Part1 = Program 1~10 (Program 1)	Select Programs To Be Run	
		Auto Pro Part2 = Program 1~10 (Program 1)		
		Auto Pro Part3 = Program 1~10 (Program 1)		
	Edit Program	Program 1	Pro. Test	Testing Program
		:	Step 01=SCxxx	Program In Loop
		Program 10	Step 64=SCxxx	Save and Exit
	Edit Scenes	Edit Scene 001 ~ Edit Scene 250	Pan,Tilt,.....	Save and Automatically Return
			--Fade Time-- ~ --Scene Time--	Manual Scenes Edit
Input By Out			Stores Scenes via Ext DMX Console	
Rec. Controller		XX~XX	Automatic Scenes Recorder	

*Function/Effect: **All**, Control, Pan, Pan Fine, Tilt, Tilt Fine, Cyan, Cyan Fine, Magenta, Magenta Fine, Yellow, Yellow Fine, CTO, CTO Fine, Red, Red Fine, Green, Green Fine, Blue, Blue Fine, Color1 Wheel, Color1 Fine, Gobo1, Gobo1_Rot, Gobo1_Rot_F, Gobo2, Gobo2_Rot, Gobo2_Rot_F, Prism, Prism_Rot, Prism_Rot_F, Focus, Focus Fine, Zoom, Zoom Fine, Auto Focus, Auto Focus_F, Strobe, Dimmer, Dimmer Fine, Dimmer Mode, Iris, Iris Fine, Frost, Animation, AnimationRot, CMY Speed, CMY Macro, Blade1A, Blade1A Fine, Blade1B, Blade1B Fine, Blade2A, Blade2A Fine, Blade2B, Blade2B Fine, Blade3A, Blade3A Fine, Blade3B, Blade3B Fine, Blade4A, Blade4A Fine, Blade4B, Blade4B Fine, AllBlade_Rot, AllBlade_Rot_F, AllBladeSpeed, AllBladeMacro, Move Speed

SYSTEM MENU

FUNCTION – Auto Program

Define fixture mode (**Primary** or **Alone**) for running Auto Programs. Select desired internal programs under “**Select Program**,” set the number of steps under “**Edit program**,” and edit individual scenes under “**Edit Scenes**.”

PERSONALITY - Status Settings - Address Via DMX

When ON, define the desired DMX address via an external controller.

NOTE: This process assumes the fixture DMX address is set to 001. If fixture DMX address is not at 001, you must adjust the channel numbers accordingly in order for this feature to work.

For example: if your fixture address is 010, then Channel 1 becomes Channel 10, Channel 2 becomes Channel 11, and Channel 3 becomes Channel 12.

1. Connect the fixture to the external controller and power ON.

2. Set the DMX value of **Channel 1** on the controller to **(7)**.

3. Set the DMX value of **Channel 2** on the controller to **(7)** or **(8)**.

When set to **(7)**, the DMX address can be set between **(1)** and **(255)**.

When set to **(8)**, the DMX address can be set between **(256)** and **(511)**.

4. Using Channel 3 on the controller set the desired DMX address of the fixture.

Example 1: If the desired DMX address is 57, set Channel 1 to a value of (7), set Channel 2 to a value of (7), and then set Channel 3 to a value of (57).

Example 2: If the desired DMX address is 420, set Channel 1 to a value of (7), set Channel 2 to a value of (8), and then set Channel 3 to a value of (164). (256+164=420)

5. After setting Channel 3 to the desired DMX address value, wait for approximately 20 seconds (some fixtures may require a longer time) for the fixture to complete the address reset function.

PERSONALITY – Service Setting - Password (050/060)

Note: The Service Password MUST be entered in order to access the service menus.

Clear Err. And USB Update.

SYSTEM MENU

PERSONALITY – Service Setting – USB Update

To update the fixture software via the **UPDATE/SERVICE PORT**, follow steps below.



ONLY QUALIFIED TECHNICIANS SHOULD PERFORM THIS FUNCTION!

NOTE ALL MENU SETTINGS BEFORE UPDATING SOFTWARE!

FIXTURE SOFTWARE CAN NOT BE DOWNGRADED!

DOWNLOAD FIXTURE SOFTWARE TO PC ONLY! (NO MAC SUPPORT)

PLEASE CONTACT ELATION SERVICE FOR FURTHER INFORMATION.

1. Copy fixture software update file from a PC computer to a compatible USB flash drive.
Make sure only the fixture software update file is stored on the USB flash drive.
2. Disconnect DMX, Art-Net, and E-FLY connections and power the fixture ON.
3. Insert USB flash drive into the **UPDATE/SERVICE PORT** on the rear connection panel.
4. Navigate to the **Personality** main menu **Service Setting / USB Update** sub menu.
5. Select the software file name on the menu display and press **ENTER**.
6. Select **YES** to begin update process and **Updating...%** will show on the menu display.
7. After file is uploaded, the fixture will check the software which will take some time.
The fixture will perform a reset process when the software update process is complete.
8. Remove the USB flash drive and make necessary system menu setting adjustments.

PERSONALITY – Display Setting – Key Lock

When ON, Control Panel buttons lock automatically after exiting main menu for 15 seconds. To unlock, keep **MODE/ESC** button pressed for 3 seconds.

PERSONALITY – Dimmer Mode

Select dimming modes (Standar, Stage, TV, Archite, Theatre, Stage2, Delay 0s, Delay 0.1s, Delay 0.2s, Delay 0.3s, Delay 0.5s, Delay 0.6s, Delay 0.7s, Delay 0.8s, Delay 0.9s, Delay 1.0s, Delay 1.5s, Delay 2.0s, Delay 3.0s, Delay 4.0s, Delay 5.0s, Delay 6.0s, Delay 7.0s, Delay 8.0s, Delay 9.0s, Delay 10s).

DIMMER

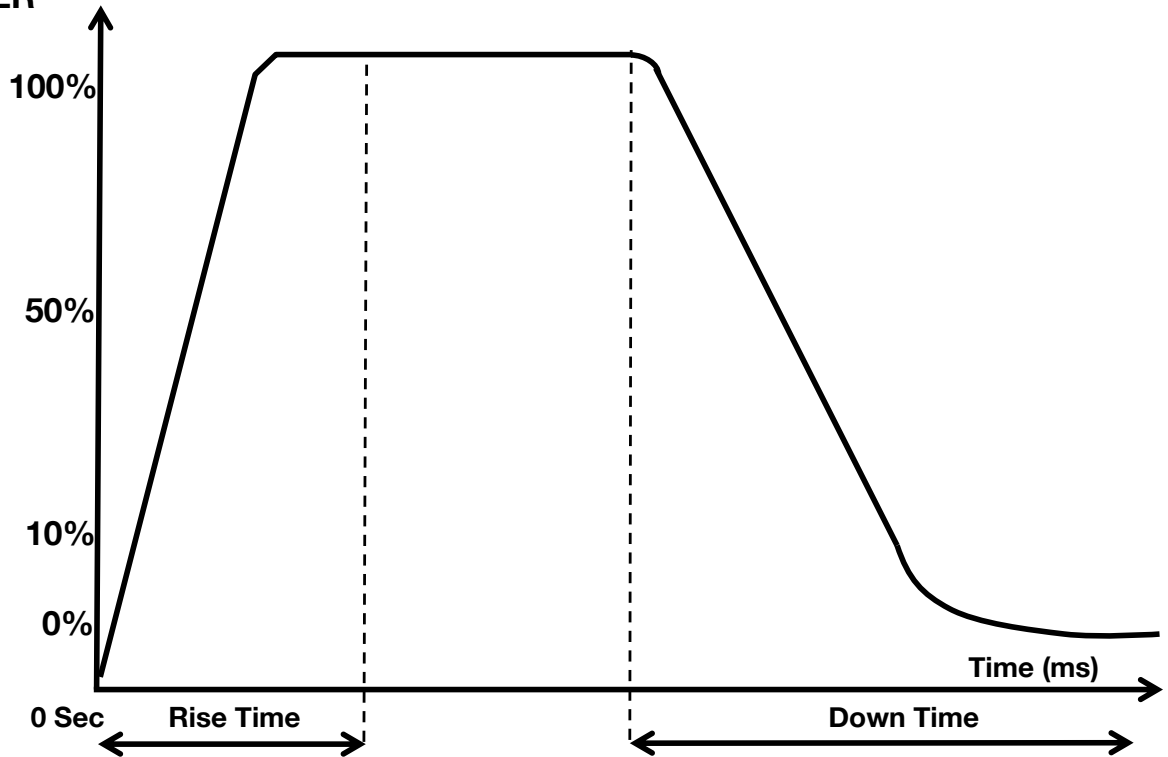

Dimming Curve Ramp Effect	0 sec Fade Time		1 sec Fade Time	
	Rise Time (ms)	Down Time (ms)	Rise Time (ms)	Down Time (ms)
Standard (default)	0	0	0	0
Stage	780	1100	1540	1660
TV	1180	1520	1860	1940
Architectural	1380	1730	2040	2120
Theatre	1580	1940	2230	2280
Stage 2	0	1100	0	1660

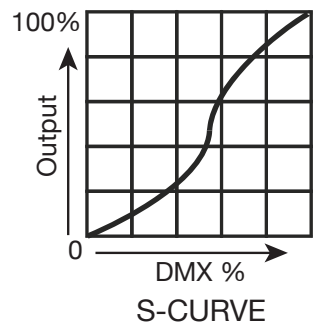
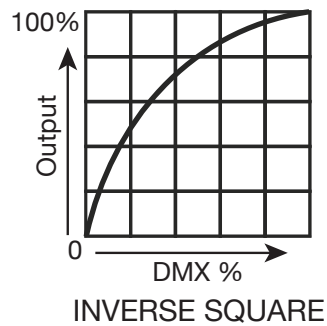
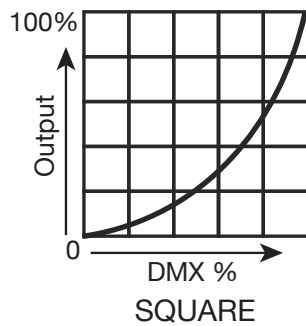
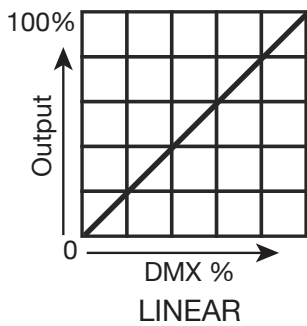

SYSTEM MENU

PERSONALITY - Reset Default (011)



**ONLY QUALIFIED TECHNICIANS SHOULD PERFORM THIS FUNCTION!
SAVED WHITE BALANCE IS ERASED AFTER RESET IS PERFORMED.**

This function restores all fixture settings to the factory default settings. The password is **011** and must be entered each time a reset is performed.

EFFECT ADJUST – Test Channel

Auto test each individual channel function independently from the DMX control board.

EFFECT ADJUST – Manual Control

Select and manually test and fine adjust each individual channel function Independently from DMX control board. This function will center PAN and TILT motors and set dimmer to 100%. PAN and TILT functions will still operate if the fixture needs to be positioned to a flat clear surface. With the individual functions, you can focus the light on a flat surface (wall) and perform fine adjustments.

EFFECT ADJUST – Calibration



ONLY QUALIFIED TECHNICIANS SHOULD PERFORM THIS FUNCTION!

This function allows small adjustments to be made to the Pan, Tilt, and Zoom movements to compensate for wear or in the event a sensor has been knocked slightly out of place. Because improper use of this function can result in undesired operation this function has been password protected. The password is **050** and must be entered each time the calibration menu function is entered. Because calibration is an extremely delicate procedure, instructions on performing this action are left out of this manual. For a first-time calibrator, please contact our customer support team for step-by-step instructions.

EDIT PROGRAM – Rec. Controller

The fixture features an integrated DMX-recorder that can be used to transmit programmed scenes from the DMX-controller to the moving head. Adjust the desired scene numbers (from – to) via the encoder. When the scenes are called at the controller, they will automatically be transmitted to the moving head.

EDIT PROGRAM – Record Controller – Working with Built-In Programs

A Primary unit can send up to 3 different data groups to the Secondary units, i.e. a Primary unit can start 3 different Secondary units, which run 3 different programs. The Primary unit sends the 3 program parts in a continuous loop.

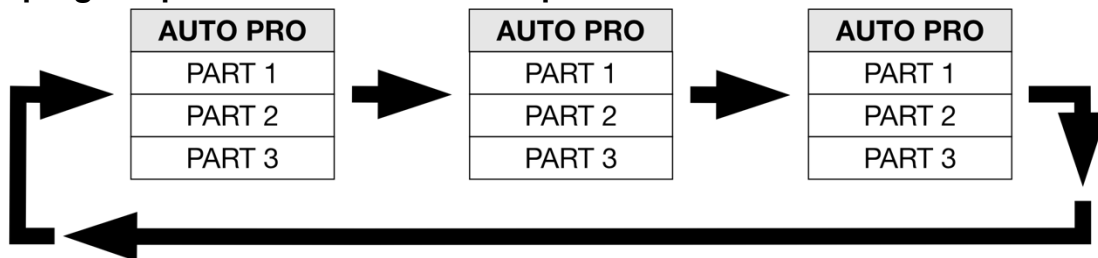

The Secondary unit receives data from the Primary unit according to the group which the Secondary unit was assigned to. If e.g. a Secondary unit is set to “**Secondary 1**” in the menu “**Set to Secondary**”, the Primary unit sends “**Auto Program Part 1**” to the Secondary unit.

If set to “**Secondary 2**”, the Secondary unit receives “**Auto Program Part 2**”.

SYSTEM MENU

EDIT PROGRAM – Record Controller – Working with Built-In Program [continued]

To start an Auto Program, proceed as follows:

1. Secondary Setting

Select “**Function Mode**”.

Press **ENTER** to confirm.

Select “**Set to Secondary**”.

Press **ENTER** to confirm.

Select “**Secondary 1**”, “**Secondary 2**” or “**Secondary 3**”.

Press **ENTER** to confirm.

Press **MODE/ESC** in order to return to the main menu.

2. Automatic Program Run

Select “**Function Mode**”.

Press **ENTER** to confirm.

Select “**Auto Program**”.

Press **ENTER** to confirm.

Select “**Primary**” or “**Alone**”.

Press **ENTER** to confirm.

Press **MODE/ESC** in order to return to the main menu.

3. Program Selection for Auto Pro Part

Select “**Edit Program**”.

Press **ENTER** to confirm.

Select “**Select Programs**”.

Press **ENTER** to confirm.

Select “**Auto Pro Part 1**”, “**Auto Pro Part 2**” or “**Auto Pro Part 3**” and select which Secondary program is to be sent. Selection “**Part 1**” means, that the Secondary unit runs the same program as the primary units.

Press **ENTER** to confirm.

Press **MODE/ESC** in order to return to the main menu.

4. Program Selection for Edit Program

Select “**Edit Program**”.

Press **ENTER** to confirm.

Select “**Edit Program**”.

Press **ENTER** to confirm.

Select the desired program to edit specific scenes into a specific program.

Press **ENTER** to confirm.

Press **MODE/ESC** in order to return to the main menu.

SYSTEM MENU

EDIT PROGRAM – Record Controller – Working with Built-In Program [continued]

5. Automatic Scene Recording

Select “**Edit Program**”.

Press **ENTER** to confirm.

Select “**Edit Scenes**”.

Select desired scene numbers. A maximum of 250 scenes can be programmed.

Press **ENTER** to confirm.

Press **MODE/ESC** in order to return to the main menu.

Example:

Program 2 includes scenes: 10, 11, 12, & 13

Program 4 includes scenes: 8, 9, & 10

Program 6 includes scenes: 12, 13, 14, & 15

Auto Pro Part 1 is Program 2

Auto Pro Part 2 is Program 3

Auto Pro Part 3 is Program 6

The 3 Secondary groups run the Auto Program in certain time segments. (See graphic below)

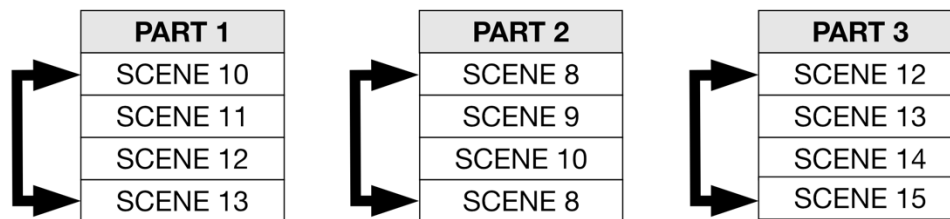

FAN MODES and LOW NOISE OPERATION

The Artiste Mondrian is a high-performance fixture suited for multiple applications. For noise critical environments such as Theater, Opera, or Orchestral Halls, it offers various fan operation modes which remove unwanted noise distractions for the audience and performers. Fan Modes can be changed remotely via the DMX control channel, allowing the fixture to offer high output or whisper-silent operation at a moment's notice. All Fan Modes smoothly transition over a brief period, preventing unwanted attraction to the fixture.

Auto (Default) –Fans only run at the speeds needed to keep the LED engine within a safe temperature range, and ensures optimal performance of the fixture. They will turn off if possible, for example, when the fixture is dimmed to a low intensity. Fans sense the ambient and fixture temperature and will, at all times, try to keep noise levels at a minimum. The fixture output will only reduce when the LED engine cannot be cooled to its safe operating range due to a high ambient temperature.

NOTE: Recommended for daily operation.

Low – Fan speeds are reduced throughout the fixture for a lower noise profile. The fixture output is also reduced to approximately 80%. This mode should be sufficient for most uses where lower noise is required.

High – Fan speeds are increased throughout the fixture for the most efficient cooling. This mode will increase wear on the fans and should only be utilized in exceptional circumstances. Fans will always run, even if the fixture is dimmed. Fixture output is kept at 100% unless the LED engine temperature reaches an unsafe temperature; at which point, the fixture will reduce power carefully to ensure continued safe operation. This mode is only required in very high ambient temperatures when automatic fan speed adjustments are not desired.

Low Noise Modes

For very critical noise environments, the fixture offers two additional Low Noise Modes for silent operation. The fixture output will be reduced, however due to the extremely high luminous flux, the fixture still offers outstanding performance. In Low Noise Modes, all parameters of the fixture operate quieter with reduced fan speeds.

Studio – Almost all fixture fans are turned off, and only run when absolutely necessary. The fixture LED power output is reduced to 50%.

Mute – All but one fixture fan is turned off for *whisper-quiet* operation. The fixture LED power output is reduced to 25%.

DMX CHANNEL FUNCTIONS AND VALUES

ELATION ARTISTE MONDRIAN™						
DMX Channel Values / Functions (42 / 68 Total DMX Channels)						
Supports Software Versions: ≥ 1.5.0						
Features subject to change without notice.						
*Rotation direction (Clockwise/Counterclockwise) and control of effects depends on head orientation and Pan/Tilt settings.						
Standard	Extended	Value	Function	Hold Time	Default	Snap
1	1		PAN Movement 8bit:		127	
		0-255	Pan Movement			
2	2		Pan Fine 16bit:		127	
		0-255	Fine control of Pan movement			
3	3		TILT Movement 8bit:		127	
		0-255	Tilt Movement			
4	4		Tilt Fine 16bit:		127	
		0-255	Fine control of Tilt movement			
5	5		Cyan:		0	
		0-255	Cyan (0-100% Cyan)			
	6		Cyan Fine:		0	
		0-255	Cyan Fine			
6	7		Magenta:		0	
		0-255	Magenta (0-100% Magenta)			
	8		Magenta Fine:		0	
		0-255	Magenta Fine			
7	9		Yellow:		0	
		0-255	Yellow (0-100% Yellow)			
	10		Yellow Fine:		0	
		0-255	Yellow Fine			
8	11		CTO:		0	
		0-255	CTO (0-100% CTO)			
	12		CTO Fine:		0	
		0-255	CTO Fine			
9	13		Red Mix:		0	
		0-255	Red (0-100% Red)			
	14		Red Mix Fine:		0	
		0-255	Red Fine			
10	15		Green Mix:		0	
		0-255	Green (0-100% Green)			
	16		Green Mix Fine:		0	
		0-255	Green Fine			
11	17		Blue Mix:		0	
		0-255	Blue (0-100% Blue)			
	18		Blue Mix Fine:		0	
		0-255	Blue Fine			

Standard	Extended	Value	Function	Hold Time	Default	Snap
12	19		Color Wheel:		0	X
		0-19	Open			
		20-37	Red			
		38-55	Green			
		56-73	UV			
		74-91	High CRI			
		92-109	Amber			
		110-127	Blue			
		128-189	Clockwise effect from fast to slow			
		190-193	No rotation			
194-255	Counter-clockwise effect from slow to fast					
	20		Color Wheel Fine:		0	X
		0-255	Fine Control of Color Wheel position			
13	21		Rotating Gobo		0	
		0-9	Open			
		10-19	Rot. gobo 1			
		20-29	Rot. gobo 2			
		30-39	Rot. gobo 3			
		40-49	Rot. gobo 4			
		50-59	Rot. gobo 5			
		60-69	Rot. gobo 6			
		70-89	Gobo 1 shake slow to fast			
		90-109	Gobo 2 shake slow to fast			
		110-129	Gobo 3 shake slow to fast			
		130-149	Gobo 4 shake slow to fast			
		150-169	Gobo 5 shake slow to fast			
		170-189	Gobo 6 shake slow to fast			
		190-221	Scroll CW fast to slow			
222-223	Stop					
224-255	Scroll CCW slow to fast					
14	22		Rotating Gobo Index, Rotation		0	
		0-127	Gobo indexing			
		128-189	Clockwise gobo scroll from fast to slow			
		190-193	No rotation			
		194-255	Counter-clockwise gobo scroll from slow to fast			
15	23		Rotating gobo fine indexing:		0	
		0-255	Fine indexing			

Standard	Extended	Value	Function	Hold Time	Default	Snap
16	24		Rotating Gobo2		0	
		0-9	Open			
		10-19	Rot. gobo 1			
		20-29	Rot. gobo 2			
		30-39	Rot. gobo 3			
		40-49	Rot. gobo 4			
		50-59	Rot. gobo 5			
		60-69	Rot. gobo 6			
		70-89	Gobo 1 shake slow to fast			
		90-109	Gobo 2 shake slow to fast			
		110-129	Gobo 3 shake slow to fast			
		130-149	Gobo 4 shake slow to fast			
		150-169	Gobo 5 shake slow to fast			
		170-189	Gobo 6 shake slow to fast			
		190-221	Scroll CW fast to slow			
		222-223	Stop			
224-255	Scroll CCW slow to fast					
17	25		Rotating Gobo Index, Rotation2		0	
		0-127	Gobo indexing			
		128-189	Clockwise gobo scroll from fast to slow			
		190-193	No rotation			
18	26		Rotating gobo fine indexing2:		0	
		0-255	Fine indexing			

Standard	Extended	Value	Function	Hold Time	Default	Snap
19	27		Rotating prism, Prism/Gobo macros:		0	X
		0-63	Open			
		64-95	4 Prism			
		96-127	4 Facet Linear			
		128-135	Macro1			
		136-143	Macro2			
		144-151	Macro3			
		152-159	Macro4			
		160-167	Macro5			
		168-175	Macro6			
		176-183	Macro7			
		184-191	Macro8			
		192-199	Macro9			
		200-207	Macro10			
		208-215	Macro11			
		216-223	Macro12			
		224-231	Macro13			
232-239	Macro14					
240-247	Macro15					
248-255	Macro16					
20	28		Rotating prism index, rotating gobo rotation:		0	
		0-127	Prism indexing			
		128-189	Clockwise prism rotation from fast to slow			
		190-193	No rotation			
	29		Rotating prism indexing Fine :		0	
		0-255	Fine indexing			
21	30		Focus:		127	
		0-255	Focus edge adjustment			
22	31		Focus Fine:		127	
		0-255	Focus adjustment Fine			
23	32		Zoom:		127	
		0-255	Zoom adjustment from small to big			
24	33		Zoom Fine:		127	
		0-255	Zoom adjustment Fine			

Standard	Extended	Value	Function	Hold Time	Default	Snap
	34		Auto Focus :		0	X
		0-50	Auto Focus Off			
		51-100	5m			
		101-150	7.5m			
		151-200	10m			
		201-255	15m			
	35		AutoFocus Fine:		0	
		0-255	Continuous adjustment Fine			
25	36		Shutter, strobe:		50	X
		0-31	Shutter closed			
		32-63	No function (shutter open)			
		64-95	Strobe effect slow to fast			
		96-127	No function (shutter open)			
		128-159	Pulse-effect in sequences			
		160-191	No function (shutter open)			
		192-223	Random strobe effect slow to fast			
		224-255	No function (shutter open)			
26	37		Dimmer:		0	
		0-255	Intensity 0 to 100%			
27	38		Dimmer Fine:		0	
		0-255	Dimmer fine			

Standard	Extended	Value	Function	Hold Time	Default	Snap
28	39		Dim Modes		0	X
		0-20	Standard			
		21-40	Stage			
		41-60	TV			
		61-80	Architectural			
		81-100	Theatre			
		101- 120	Stage 2			
			Dimmer Delay Time			
		121	0s			
		122	0.1s			
		123	0.2s			
		124	0.3s			
		125	0.4s			
		126	0.5s			
		127	0.6s			
		128	0.7s			
		129	0.8s			
		130	0.9s			
		131	1.0s			
		132	1.5s			
		133	2.0s			
		134	3.0s			
		135	4.0s			
		136	5.0s			
137	6.0s					
138	7.0s					
139	8.0s					
140	9.0s					
141	10s					
142 - 255	Idle					
29	40		Iris:		0	
		0-191	Max. diameter to Min. diameter			
		192-223	Pulse closing fast to slow			
		224-255	Pulse opening slow to fast			
	41		Iris Fine:		0	
		0-255	Iris Fine			
30	42		Frost		0	
		0-127	Open to Light Frost			
		128-255	Open to Wash Frost			
31	43		Animation wheel:		0	
		0-7	Open			
		8-255	Animation min to max			
32	44		Animation index, animation rotation:		0	
		0-127	Animation indexing			
		128-189	Clockwise animation rotation from fast to slow			
		190-193	No rotation			
		194-255	Counter-clockwise animation rotation from slow to fast			

Standard	Extended	Value	Function	Hold Time	Default	Snap
	45		Speed Of CMY & Color macro Speed:		0	
		0-255	Speed Max →Min			
			Color macros - CMY and color wheel:			
		0-31	OFF			
		32-39	Macro1			
		40-47	Macro2			
		48-55	Macro3			
		56-63	Macro4			
		64-71	Macro5			
		72-79	Macro6			
		80-87	Macro7			
		88-95	Macro8			
		96-103	Macro9			
		104-111	Macro10			
		112-119	Macro11			
		120-127	Macro12			
	46	128-135	Macro13		0	X
		136-143	Macro14			
		144-151	Macro15			
		152-159	Macro16			
		160-167	Macro17			
		168-175	Macro18			
		176-183	Macro19			
		184-191	Macro20			
		192-199	Macro21			
		200-207	Macro22			
		208-215	Macro23			
		216-223	Macro24			
		224-231	Macro25			
		232-239	Macro26			
		240-247	Macro27			
		248-255	Random CMY			

Standard	Extended	Value	Function	Hold Time	Default	Snap
33	47		Blade 1A		0	
		0-255	Open to Close			
	48		Blade 1A Fine		0	
		0-255	Open to Close Fine			
34	49		Blade 1B		0	
		0-255	Open to Close			
	50		Blade 1B Fine		0	
		0-255	Open to Close Fine			
35	51		Blade 2A		0	
		0-255	Open to Close			
	52		Blade 2A Fine		0	
		0-255	Open to Close Fine			
36	53		Blade 2B		0	
		0-255	Open to Close			
	54		Blade 2B Fine		0	
		0-255	Open to Close Fine			
37	55		Blade 3A		0	
		0-255	Open to Close			
	56		Blade 3A Fine		0	
		0-255	Open to Close Fine			
38	57		Blade 3B		0	
		0-255	Open to Close			
	58		Blade 3B Fine		0	
		0-255	Open to Close Fine			
39	59		Blade 4A		0	
		0-255	Open to Close			
	60		Blade 4A Fine		0	
		0-255	Open to Close Fine			
40	61		Blade 4B		0	
		0-255	Open to Close			
	62		Blade 4B Fine		0	
		0-255	Open to Close Fine			
41	63		Framing Index / Rotation:		0	
		0-127	Index (0-360 degrees)			
		128-189	CW rotation from fast to slow			
		190-193	No rotation			
		194-255	CCW rotation from fast to slow			
	64		Framing Rotation Fine:		0	
		0-255	Framing Rotation Fine			
	65		Framing Speed:		0	
		0-255	Speed Max →Min			

Standard	Extended	Value	Function	Hold Time	Default	Snap
			Framing Macro:			
		0-7	OFF			
		8-15	Macro1			
		16-23	Macro2			
		24-31	Macro3			
		32-39	Macro4			
		40-47	Macro5			
		48-55	Macro6			
		56-63	Macro7			
		64-71	Macro8			
		72-79	Macro9			
		80-87	Macro10			
		88-95	Macro11			
		96-103	Macro12			
		104-111	Macro13			
		112-119	Macro14			
	66	120-127	Macro15		0	X
		128-135	Macro16			
		136-143	Macro17			
		144-151	Macro18			
		152-159	Macro19			
		160-167	Macro20			
		168-175	Macro21			
		176-183	Macro22			
		184-191	Macro23			
		192-199	Macro24			
		200-207	Macro25			
		208-215	Macro26			
		216-223	Macro27			
		224-231	Macro28			
		232-239	Macro29			
		240-247	Macro30			
		248-255	Macro31			

Standard	Extended	Value	Function	Hold Time	Default	Snap	
	67		Pan / Tilt Speed:		0	X	
		0-225	Max to min speed				
		226-235	Blackout by movement				
		236-245	Blackout by all wheel changing				
		246-255	No function				
42	68		Control:		0	X	
		0-19	Color change normal				
		20-29	Color change to any position				
		30-39	Color & gobo change to any position	0s			
		40-44	Low Noise - Mute	1s			
		45-49	Low Noise - Studio				
		50-54	Fan Control - Low				
		55-59	Fan Control - High				
		60-64	Fan Control - Auto (Default)				
			65-79	Idle			3s
			80-84	All motor reset			
			85-87	Pan / Tilt reset			
			88-90	Color reset			
			91-93	Gobo reset			
			94-96	Focus and Zoom reset			1s
			97-99	Other motor reset			
			100-168	Refresh Rate (Hz)			
			100	900			
			101	910			
			102	920			
			103	930			
			104	940			
			105	950			
			106	960			
			107	970			
			108	980			
			109	990			
			110	1000			
			111	1010			
			112	1020			
			113	1030			
			114	1040			
			115	1050			
			116	1060			
	117	1070					
	118	1080					
	119	1090					
	120	1100					
	121	1110					
	122	1120					
	123	1130					
	124	1140					
	125	1150					
	126	1160					

Standard	Extended	Value	Function	Hold Time	Default	Snap
42	68	127	1170	1s	0	x
		128	1180			
		129	1190			
		130	1200			
		131	1210			
		132	1220			
		133	1230			
		134	1240			
		135	1250			
		136	1260			
		137	1270			
		138	1280			
		139	1290			
		140	1300			
		141	1310			
		142	1320			
		143	1330			
		144	1340			
		145	1350			
		146	1360			
		147	1370			
		148	1380			
		149	1390			
		150	1400			
		151	1410			
		152	1420			
		153	1430			
		154	1440			
		155	1450			
		156	1460			
		157	1470			
		158	1480			
		159	1490			
		160	1500			
		161	2500			
		162	4000			
		163	5000			
		164	6000			
		165	10000			
		166	15000			
		167	20000			
		168	25000			
169-176	Idle					

Standard	Extended	Value	Function	Hold Time	Default	Snap
		177-178	Hibernation Off	1s		
		179-180	Hibernation			
		181-190	smooth mode (Pan/Tilt brake) (default)			
		191-200	fast mode (Pan/Tilt brake)			
		201-210	Dimmer Curve Linear (default)			
		211-220	Dimmer Curve Square			
		221-230	Dimmer Curve Inverse Square			
		231-240	Dimmer Curve S-Curve			
		241	Internal program 1 (scene1~8 of EEPROM)			
		242	Internal program 2 (scene9~16 of EEPROM)			
		243	Internal program 3 (scene17~24 of EEPROM)			
		244	Internal program 4 (scene25~32 of EEPROM)			
		245	Internal program 5 (scene33~40 of EEPROM)			
		246	Internal program 6 (scene41~48 of EEPROM)			
		247	Internal program 7 (scene49~56 of EEPROM)			
		248-249	CMY Normal			
		250-251	CMY Fast (default)			
		252-255	Idle			

ERROR CODES

When power is applied, the unit will automatically enter a “**Reset/Test**” mode. This mode brings all the internal motors to a home position. If there is an internal problem with one or more of the motors an error code will flash in the display in the form of “**XXEr**” where as XX will represent a function number. For example, when the display shows “**0Er**” it means there is some type of error with the Pan motor. If there are multiple errors during the start-up process they will all flash in the display. For example: if the fixtures has errors on **Channel 1, 2, and 5** all at the same time, you will see the error message “**01Er**”, “**02Er**”, and “**05Er**” flash repeated 5 times.

If an error does occur during the initial start-up procedure the fixture will self-generate a second reset signal and try to realign all the motors and correct the errors. If the error persists after a second attempt a third attempt will be made. If after a third attempt all the errors have not been corrected the fixture will make the following determinations:

3 or More Errors - The fixture cannot function properly with three or more errors; therefore, the fixture will place itself in a stand-by mode until subsequent repairs can be made.

Less Than 3 Errors - The fixture has less than 3 errors; therefore, most other functions will work properly. The fixture will attempt to operate normally until the errors can be correct by a technician. The errors in question will remain flashing in the display as a reminder of internal errors.

Error Codes subject to change without notice.	
ERROR CODES	DESCRIPTION
PAN Er	Movement is not located in the default position after the reset. This message will appear after a fixture reset if the magnetic-indexing circuit malfunctions (sensor failed, or magnet is missing) or there is a motor failure (defective motor or a defective motor IC drive on the main PCB). This error may also be displayed if the head/yoke was blocked during a reset function.
TILT Er	
Cyan Color Er	Movement is not located in the default position after the reset. This message will appear after a fixture reset if the magnetic-indexing circuit malfunctions (sensor failed, or magnet is missing), or there is a motor failure (defective motor or a defective motor IC drive on the main PCB).
Magenta Color Er	
Yellow Color Er	
CTO Color Er	
Color Wheel1 Er	
Focus Er	
Zoom Er	
Iris Er	
AllBladeRotation Er	
Prism1 Er	
Prism2 Er	
Prism_Rot1 Er	
Prism_Rot2 Er	
Animation Er	
AnimationRot Er	

SPECIFICATIONS

SOURCE

950W 6,500K Bright White LED Engine
30,000 Hour Average LED Life*

*Test lab conditions. May vary depending on several factors including but not limited to:
Environmental Conditions, Power/Voltage, Usage Patterns (On-Off Cycling), Control, and Dimming.

PHOTOMETRIC DATA

51,000 Total Lumen Fixture Output
CRI 72+ (84+ with HCRI Filter)
Zoom Angle 3° - 45°
Beam Angle 2.8° - 34.9°
Field Angle 4° - 46.1°

EFFECTS

Motorized Zoom (226mm / 8 3/4" front lens)
4 Rotating Full Blackout Framing Blades
360° Continuous Framing Index and Rotation
Full 360° Bi-Directional Animation Wheel
2 Rotating Prisms
2 Variable Frost Filters (Light and Wash)
Internal Color, Framing, Prism, and Frost Macros
Motorized Iris with Variable Pulse Effects
Variable 16-bit Dimming Curve Modes
High Speed Electronic Shutter and Strobe
DMX Controllable LED Refresh Rate
Pan Angle: 540° / 630°
Tilt Angle: 250°

COLOR

SpectraColor CMY + RGB Color Mixing Array
6 Dichroic Colors including High CRI Filter and UV
Linear CTO Color Correction

GOBOS

2 Gobo Wheels
12 Rotating / Indexing Interchangeable Glass Gobos

CONTROL / CONNECTIONS

2 DMX Channel Modes (42 / 68)
16-bit Pan, Tilt and Dimming Control
Motorized Focus and Auto-Focus Presets
DMX, RDM, Art-NET, sACN Protocol Support
(6) Button Touch Control Panel
Full Color 180° Reversible LCD Menu Display
Hibernation Mode (Power Save)
Locking 5pin XLR DMX, RJ45 Ethernet, and Power
USB Connection (Firmware Updates)
With Wired Digital Communication Network

SIZE / WEIGHT

Length: 18.55 in. (472mm)
Width: 26.5 in. (673mm)
Height: 34.2 in. (870mm)
Weight: 104.7 lbs. (47.5kg)

ELECTRICAL/THERMAL

AC 120-240V 50/60Hz
Max Power Consumption 1,500W
BTU/hr (+/- 10%) 5115

APPROVALS / RATINGS

CE | cETLus | IP20

Specifications and documentation subject to change without notice.

DIMENSIONAL DRAWINGS

*DRAWINGS NOT TO SCALE

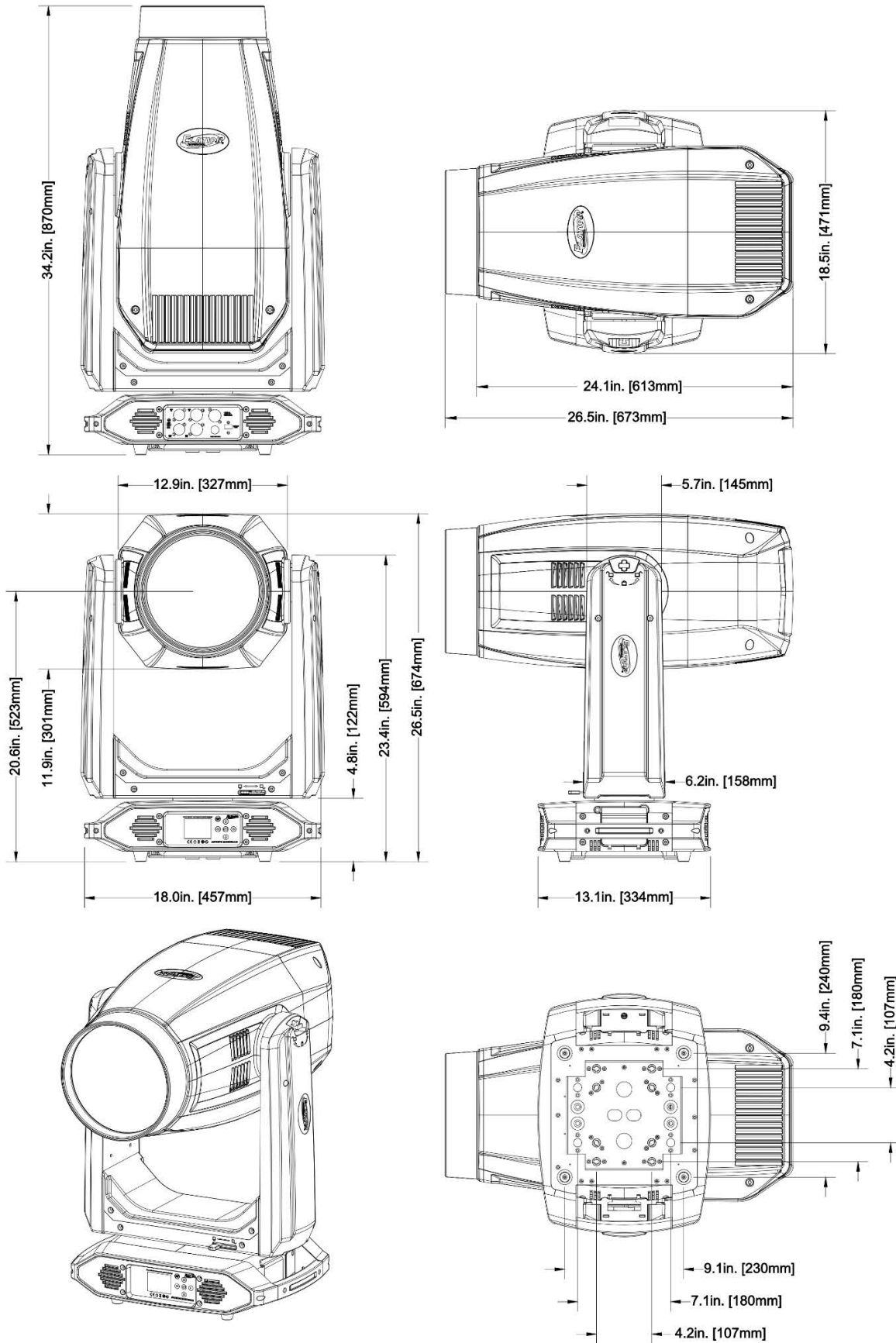

Specifications and improvements in the design of this unit and this manual are subject to change without notice.

OPTIONAL ACCESSORIES

ORDER CODE	ITEM
TRIGGER CLAMP	Heavy Duty Wrap Around Hook Style Clamp
AC5PDMX5PRO	5 ft. (1.5m) 5pin PRO DMX Cable
CAT6PRO5	5 ft. (1.5m) CAT6 Ethernet. Cable
NEU096	5 ft. (1.5m) Locking Power-Link Cable
	Additional Cable Lengths Available

FCC STATEMENT

This device complies with Part 15 of the FCC Rules. Operation is subject to the following two conditions: (1) this device may not cause harmful interference, and (2) this device must accept any interference received, including interference that may cause undesired operation.

FCC RADIO FREQUENCY INTERFERENCE WARNINGS & INSTRUCTIONS

This product has been tested and found to comply with the limits as per Part 15 of the FCC Rules. These limits are designed to provide reasonable protection against harmful interference in a residential installation. This device uses and can radiate radio frequency energy and, if not installed and used in accordance with the included instructions, may cause harmful interference to radio communications. However, there is no guarantee that interference will not occur in a particular installation. If this device does cause harmful interference to radio or television reception, which can be determined by turning the device off and on, the user is encouraged to try to correct the interference by one or more of the following methods:

- Reorient or relocate the device.
- Increase the separation between the device and the receiver.
- Connect the device to an electrical outlet on a circuit different from which the radio receiver is connected.
- Consult the dealer or an experienced radio/TV technician for help.

Europe Energy Saving Notice

Energy Saving Matters (EuP 2009/125/EC)

Saving electric energy is a key to help protecting the environment. Please turn off all electrical products when they are not in use. To avoid power consumption in idle mode, disconnect all electrical equipment from power when not in use. Thank you



